

CO2-Humidity-Temp Transmitter w/ Bacnet

Description

The CO2 sensor with Humidity & Temp transmitters are designed for environmental monitoring and controlling in industrial, commercial and other buildings. These transmitters can be used for indoor CO2, temperature and humidity monitoring. The modbus interface provides easy setup and integration into large systems. In addition, both CO2-D and CO2-W have an ethernet port.



CO2-D



CO2-W

Highlights

- High performance sensing elements, temperature compensated, stable
- RS485 for direct digital reading on all models, Ethernet option available for Duct/Wall types
- Easy troubleshooting with pluggable sensors and backplate
- Transducer outputs are jumper selectable: 4-20mA, 0-5V or 0-10V
- LCD display with backlight on all models except 'the Node'
- Automatic background calibration, default CO2 value: 400 ppm
- CO2 D/W style featured as pluggable sensor module with stainless steel sintered filter
- Enthalpy, its calculated automatically and available in the register list and display

CO2-N-TH Highlights:

CO2-N-TH is indoor wall mount CO2, Temp & Hum sensor
High performance sensing elements, temperature compensated, stable

CO2-N-X Highlights:

CO2-N-X is indoor wall mount CO2 sensor
Good quality and low cost

CO2-N-TH & CO2-N-X:

Modbus RS485 with 0-5V, 0-10V and 4-20mA outputs, support Bacnet MS/TP

Available in red and white, other colors optional

Red/yellow/green LED shows the quality and safety of the air, and blue LED shows good communication



Specifications

Sensing	CO2	HUM	TEMP
Sensor Type	Dual Beam NDIR	Capacitive	10k thermister
Range	3,000 ppm, adjustable	0-100% Non-Condensing	-40~150°C(-60~340°F)
Accuracy	±70 ppm or ±5% of reading	3% @25°C, 20~80%	< ±0.5°C @ 25°C
Drift	<50ppm / yr full scale	< 0.5% RH / year	
Display Resolution	1ppm	0.1% RH	0.1Deg

CO2-Humidity-Temp Transmitter w/ Bacnet

Models	CO2-D	CO2-W	CO2-Node	Tstat6-CO2
Typical Application	Duct	Wall, outside	Wall mount indoors	Wall mount indoors
Outputs	3	3	3	2
Output Signal Type	Jumper select: 4-20mA, 10V, 5V			10V & 5V
Output Signal Drive	> 500Ω for ma mode, 75ma max output drive for voltage mode			75ma @10V
RS485 ports	2	2	1	1
Ethernet Modbus TCP/IP	CO2-D-E	CO2-W-E	not available	not available
Power	15-24V +/- 10%, AC or DC , 2 watt typical			
Operating Temp	-30~+70C, 0-95% non condensing			
Plastic Housing	Flammability rating UL 94V0 file E194560, plastic is halogen free			
Display	130x80 dot matrix, backlit		4 leds	2x8char
Control Features	Master/Gateway Mode		N/A	Same as Tstat6

Note:

1. The default setting for the transducers is 0 to 10V, over the range 0 to 100 Degrees C. If you're using the 10V transducer output signal, the sensor needs to be powered with at least 15V AC or DC.
2. For application not using the 10V transducer output signal, using 4-20ma signal, 0-5V transducers, or Modbus/Ethernet only, in this case you can use 12V AC or DC.

Dimensions

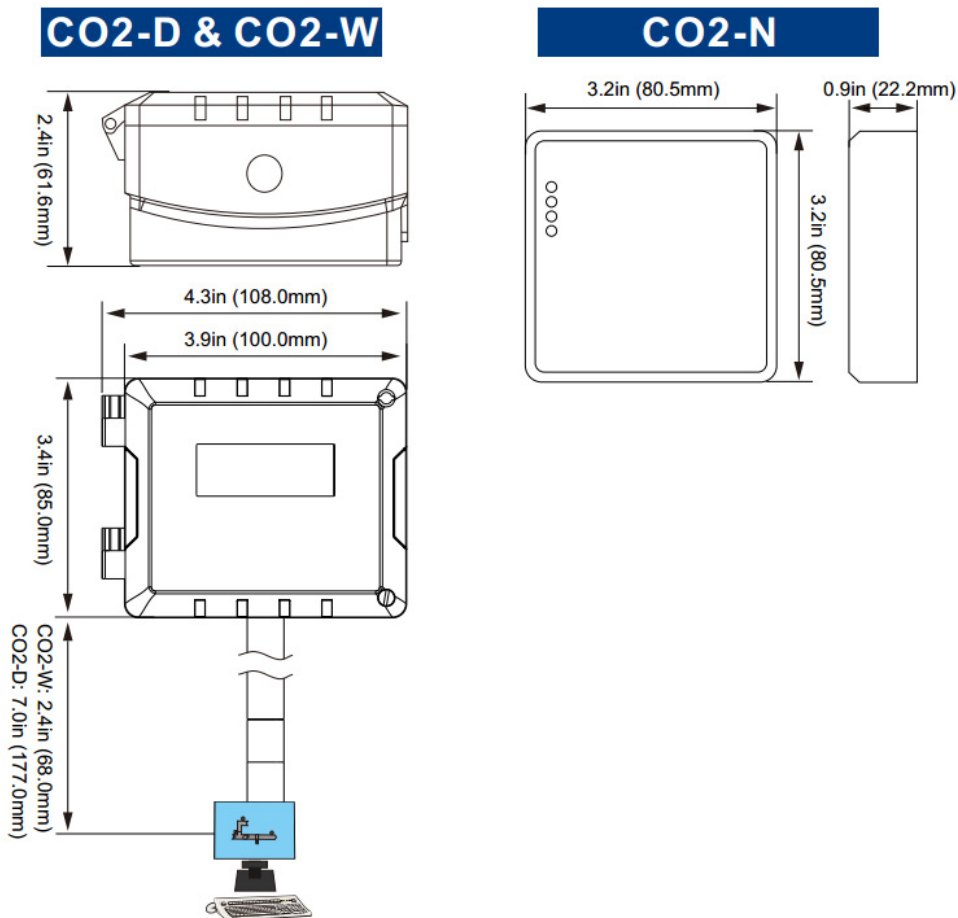

CO2-Humidity-Temp Transmitter w/ Bacnet

Part Number Scheme

CO2 - D - TH

Code	Description
CO2	CO2 Sensor

Code	Module
D	Duct Mount
W	Wall Mount
N	CO2 Node

Code	Option
X	CO2 only
TH	Temperature & Humidity

Product	Model	Temp	Hum	CO2	RS485	Ethernet	Pitot	Picture
CO2-D	-TH	✓	✓	✓	✓	✓	✓	
	-X	x	x	✓	✓	✓	✓	
CO2-W	-TH	✓	✓	✓	✓	✓	x	
	-X	x	x	✓	✓	✓	x	
CO2-N	-X	✓	✓	✓	✓	✓	x	
	-TH	✓	✓	✓	✓	✓	x	

CO2 - N - TH - W

Code	Description
CO2	CO2 Sensor

Code	Module
N	CO2 Node

Code	Option
W	White Enclosure
O	Other Colors Optional*
Code	Option
X	RS485
TH	Temp & Hum & RS485

* MOQ: 100pcs

CO2-Humidity-Temp Transmitter w/ Bacnet

Product Highlights

CO2-W & CO2-D

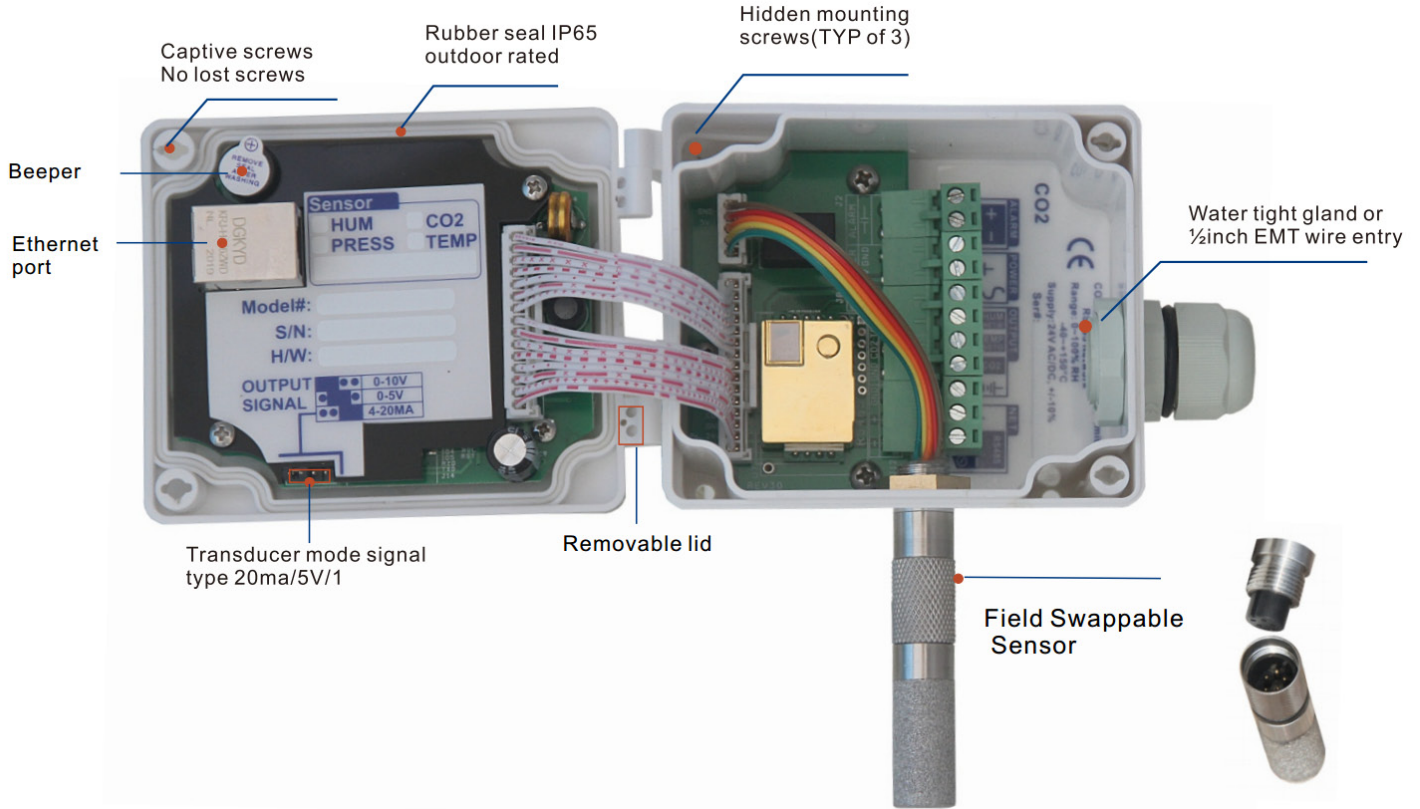

Tstat6 -CO2

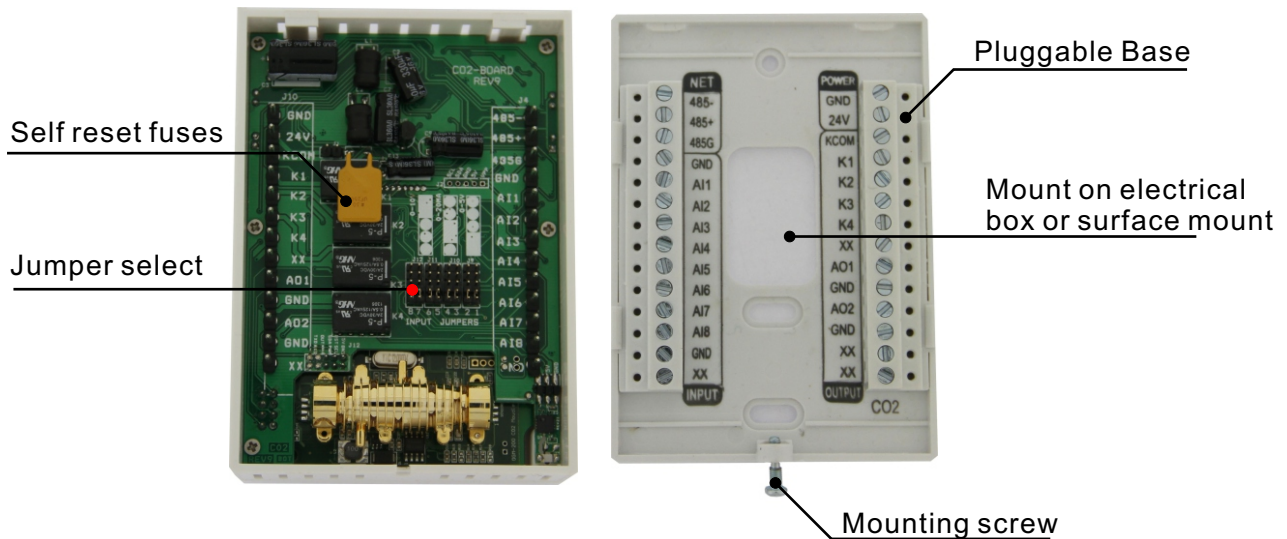

CO2-Humidity-Temp Transmitter w/ Bacnet

Modbus Register List

CO2-Humidity-Temp Transmitter w/Bacnet uses MODBUS protocol to communicate with others. Below is the Modbus register list.

Address	Bytes	Register Description
1...2	2	Lower 2 bytes of the serial number
2..3	2	Upper 2 bytes of the serial number
4	1	firmware version lower byte. eg. FW version=10.12, so lower byte=12AND high byte=10. Fixed.
5	1	firmware version upper byte. eg. FW version=10.12, so lower byte=12AND high byte=10. Fixed.
6	1	Modbus device address default:254
7	1	Product ID,Fixed
8	1	Hardware version
9	1	spare
10	1	spare
14	1	sensor type,Bit0=co2,Bit1=Hum,Bit2=Temp, Bit3=Pressure
15	1	Baudrate Setting:0=9600bps,1=19200bps,2=38400bps,3=57600bps,4=115200bps,default:11.5kbaud
16	1	Firmware Update Register,used to show the status of firmware updates
21	1	Protocol switch.3=MODBUS,0=MSTP. Default:Modbus
17....39	23	spare
40 to 45	6	reg40,MAC,address,read only normally
46	1	reg46,IP mode 0=static IP; 1=DHCP default:static
47 to 48	2	reg47,upper two bytes of IP address default:192.168
49 to 50	2	reg49, upper two bytes of IP address default:0.34
51 to 52	2	reg51,right two bytes of SUBNET MASK address
53 to 54	2	reg53,left two bytes of SUBNET MASK address
55 to 56	2	reg55,right two bytes of GATEWAY address
57 to 58	2	reg57,left two bytes of GATEWAY address
59	1	reg59,0,TCP server,(NO USE)
60	1	reg60,listen port at TCP server mode
61~75		buffer mirror for changing to a new IP address,copy of reg 46 to 60
76	1	write 1 to set the ghost setting to the system and start new settings, then clear the ghost registers
93	1	Enable for MAC setting.It should be set as 1 before write the new MAC to the MACregisters(100-105),and it will be cleared automatically after setting the MAC address
94...199	7	Reserved for future
200	1	Temperature sensor selection,0=external,1=internal.Read only,it will be set to 1 if the humidity module exists

CO2-Humidity-Temp Transmitter w/ Bacnet

Address	Bytes	Register Description
201	1	Select the unit of temperature to display on LCD.0=degree Celsius.1=degree Fahrenheit
202	1	The value of on board temperature sensor,the unit is degree Celsius.The resolution is 0.1 degree
203	1	The value of on board temperature sensor,the unit is degree Fahrenheit.The resolution is 0.1 degree
204	2	The value of external temperature sensor,the unit is degree Celsius.The resolution is 0.1 degree
205	2	The value of external temperature sensor,the unit is degree Fahrenheit.The resolution is 0.1 degree
206	2	The temperature offset for calibrating the internal temperature.The resolution is 0.1degree
207	2	Relative humidity.The resolution is 0.1%
208	2	Read only.The real frequency read from the humidity module,unuse
209	1	Read only.The number of the calibration table points.
210	1	Internal CO2 sensor selection.The value is 1 as default.1=MAYBE_OGM200;2=MAYBE_TEMCO_CO2;3=OGM200;4=TEMCO_CO2
211	2	The CO2 ppm value of internal CO2 sensor
212	2	The CO2 ppm offset for calibrating internal CO2 sensor
213	2	The setpoint value of fair alarm for internal CO2 sensor
214	2	The setpoint poor of fair alarm for internal CO2 sensor
215..468	2*254	The CO2 ppm value of the external CO2 sensors if there are/is CO2 nodes connect to it
469..722	2*254	The CO2 ppm offset for calibrating external CO2 sensor
723..976	2*254	The setpoint value of fair alarm for external CO2 sensor
977..1230	2*254	The setpoint value of poor alarm for external CO2 sensor
1231	2	reserve
1232	1	The filter of CO2 sensor
1234	1	Enable/Disable the password for the menu system operation.0=Disable 1=Enable
1235	1	The second digital of the password.Should be from 0 to 9
1236	1	The third digital of the password.Should be from 0 to 9
1237	1	The fourth digital of the password.Should be from 0 to 9
1238	1	The century of the real time clock
1239	1	The year of the real time clock
1240	1	The month of the real time clock
1241	1	The date of the real time clock
1242	1	The weekday of the real time clock
1243	1	The hour of the real time clock
1244	1	The minute of the real time clock

CO2-Humidity-Temp Transmitter w/ Bacnet

Address	Bytes	Register Description
1245	1	The second of the real time clock
1246	1	Alarm auto/manual control.Bit7: 0=auto,1=manual;1=pre_alarm;bit1:1=continuous_alarm;bit(1:0):00 =stop_alarm
1247	1	The alarm output turn on time,<=20 seconds.
1248	1	The alarm output turn off time,<=20 seconds.
1249	1	Alarm output delay time.It delays the alarm output when the alarm is triggered.It is 5 seconds as default.
1250	1	Analog output auto/manual control.Bit 0 directs to temperature output, Bit 1 directs to humidity output,Bit 2 directs to CO2 output.0=Auto,1=Manual.
1251	2	The manual value of temperature
1252	2	The manual value of humidity
1253	2	The manual value of CO2
1254	1	Analog output mode,read only,select by jumper.1=0-10V,2=0-5V,3=4-20mA
1255	2	The lowest value of temperature for analog output
1256	2	The Highest value of temperature for analog output
1257	2	The Lowest value of humidity for analog output
1258	2	The Highest value of humidity for analog output
1259	2	The lowest value of CO2 for analog output
1260	2	The Highest value of CO2 for analog output
1261	1	Reserve
1262	1	The period for the LCD backlight keep on.The backlight turns on when key is triggered and turns off the it expires.
1263	1	Enable/Disable the plug-play feature of the external nodes.0=disable 1=enable
1264	1	The number of CO2 sensors connect to the unit. includes the internal CO2 sensor
1265	1	Set 1 to reset the scan table
1266..1270	1*5	The first CO2 node sensors information.Normally it is the unit itself
		register 1266:the modbus ID of the CO2 sensor
		register1267..1270:the serial number of the CO2 sensor
1271..1275	1*5	The second CO2 node information.Normally,it is the first external CO2 node
1276..1280	1*5	The third CO2 node information.
...		
...		
2531..2535	1*5	The 254th CO2 node information
3000	1	The internal temperature filter
3001	1	The external temperature filter
3002	1	The humidity filter
3003	1	The humidity sensor version

CO2-Humidity-Temp Transmitter w/ Bacnet

Address	Bytes	Register Description
3004	2	The humidity sensor serial number
3005	1	The humidity sensor factory calibrate point number
3006	1	The humidity sensor calibrate table select 0=factory 1=user table
3007..3026	2*254	factory calibrate table.Register3007:The 1st Calibrate point,Frequency,Register3029: The 1st Calibration point.Frequency
3027	1	user calibration table point number
3028..3047	2*254	user calibrate table. Register3028:The 1st Calibrate point RH,Frequency,Register3029: The 1st Calibration point.Frequency
3049	2	The dew point.In degree C
3050	2	The dew point . In degree F
3051	2	The Lowest value of dew point for analog output
3052	2	The heighest value of dew point for analog output
3053	2	Partial pressure of water at saturation at given temperature [hPa]
3054	2	Mixing Ratio,the mass of water over the mass of dry gas[g/kg]
3055	2	Enthalpy of the air,[KJ/kg]
3056	2	The external temperature offset
3057	2	The user table humidity offset
3058	2	The default table humidity offset
3066	2	The analog output value of humidity(0.01ma/0.01v)
3067	2	The analog output value of temperature
3068	2	The analog output value of CO2

CO2-Humidity-Temp Transmitter w/ Bacnet

Bacnet

CO2-Humidity-Temp Transmitter w/Bacnet uses Bacnet protocol to communicate with others. Below is the Bacnet register list.

Backed Object	Variable and Description
Variable1	Serial Number Low Byte
Variable2	Serial Number High Byte
Variable3	SoftWare Version
Variable4	Device ID
Variable5	Product Model
Variable6	Instance
Variable7	Station number
Variable8	Uart BaudRate.0=9.6kbaud,1=19.2kbaud 2=38.4kbaud 3=57.6kbaud 4=115.2kbaud
Variable9	Update
Variable10	Protocol
Variable11	Auto/Manual
Variable12	Dew point
Variable13	Pws
Variable14	Lowest ratio
Variable15	Enthalpy
Variable16	OffSet CO2
Variable17	Filter Temperature
Variable18	OffSet CO2
Variable22	Filter Humidity
Variable23	Filter Temperature
Variable24	Filter CO2
Variable28	Temperature Unit.0=C,1=F
Variable29	OutMode.1=0-10v,2=0-5v,3=4-20mA
Variable30	Output1 Lowest Range
Variable31	Output1 Hightest Range
Variable32	Output2 Lowest Range
Variable33	Output2 Hightest Range
Variable34	Output3 Lowest Range
Variable35	Output3 Hightest Range

CO2-Humidity-Temp Transmitter w/ Bacnet

	Input and Description
Input1	Temperature
Input2	Humidity
Input3	CO2

	Output and Description
Output1	Humidity/Analog output
Output2	Temperature Analog output
Output3	CO2 Analog output

CO2-Humidity-Temp Transmitter w/ Bacnet

Wiring diagram for CO2-D duct and CO2-W wall mount style

The diagram below shows the wiring connection for the usual transducer mode of operation for the CO2-D duct mount and CO2-W wall mount style sensors. The transducer outputs connect to a master controller using traditional analog output signals. The RS485 network is available for transmitting the same values digitally to other controllers in the system by connecting to the RS485 network at Pins 10 and 11.

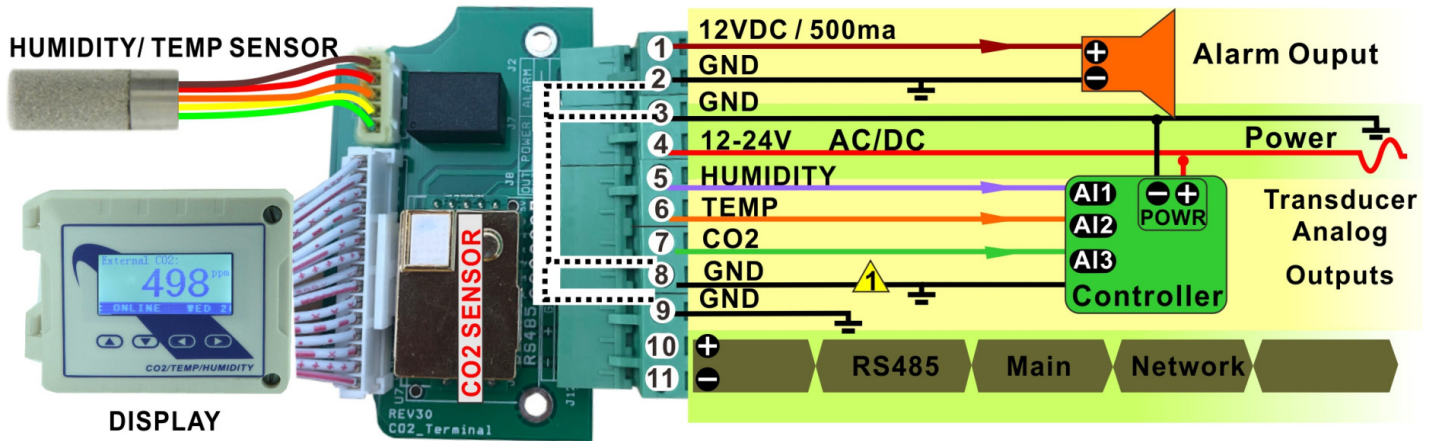

The next diagram shows the wiring connection in 'Master' mode where the device operates as a gateway to a subnetwork of slave sensors. This is a special mode of operation and most users needn't to be concerned about the details of this feature. The main RS485 network is still available on pins 10 and 11 for connecting to

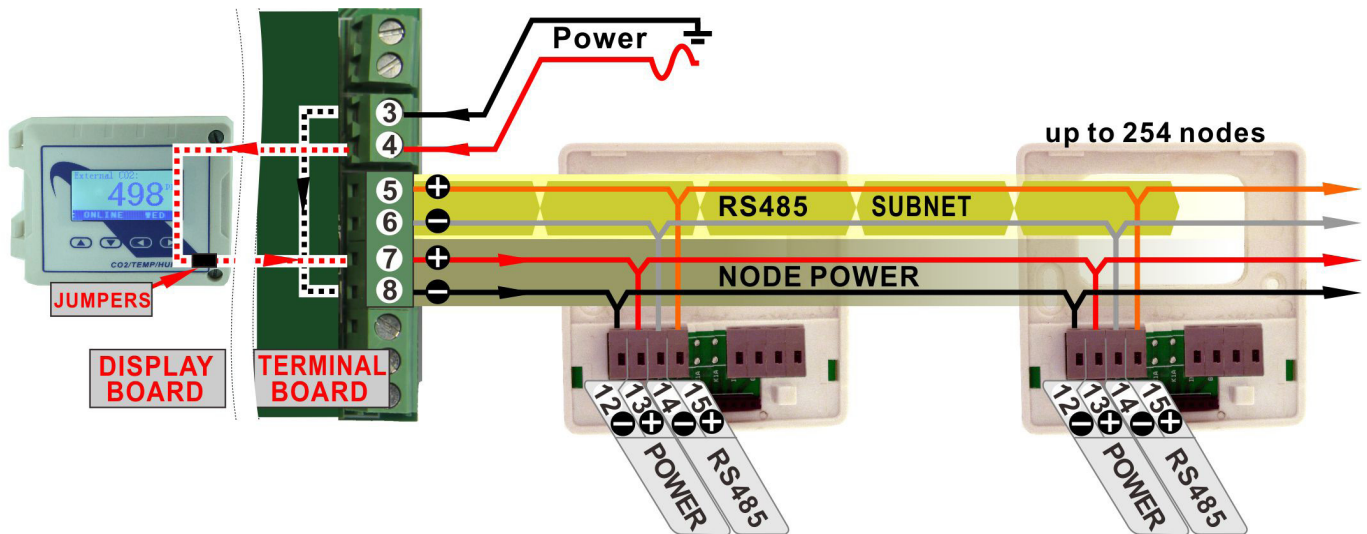

other masters in the system as above, but the transducer analog signals are not available now, instead we now have a second RS485 port which can be used to poll a subnetwork of remote RS485 CO2 sensors. The unit acts as a modbus slave on the main network and a master on the subnetwork. Power to the nodes can be run from Pins 5 and 6 along with the RS485 cable, in this case power makes its way through the display board and jumpers as shown with the dotted lines. If there are more than five

CO2-Humidity-Temp Transmitter w/ Bacnet

or so sensor nodes it will be best to power the nodes directly from the power supply. If more than one power supply is used in the system, be extra careful to keep all grounds consistent from one node to the next or else ground loops can damage the sensor. The Duct and Wall mount version of the sensor have two modes of operation, transducer mode and RS485 Master mode. For most applications the sensor will be used in the 'transducer mode' which is the default setting. In this mode the device acts as a traditional transducer where it sends out three analog signals proportional to the humidity, temperature and CO2 readings.

Output Jumper settings

In this mode the device acts as a traditional transducer where it sends out three analog signals, all you need to do is to set this one single jumper to the appropriate signal type: 4-20mA, 0-10V, or 0-5V.

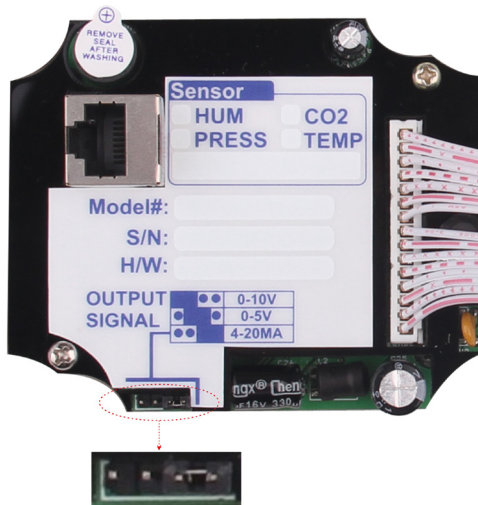

Ethernet Wiring

For Ethernet option, CO2-D/W has two choices, with and without, here we show a photo about how to connect with Ethernet.

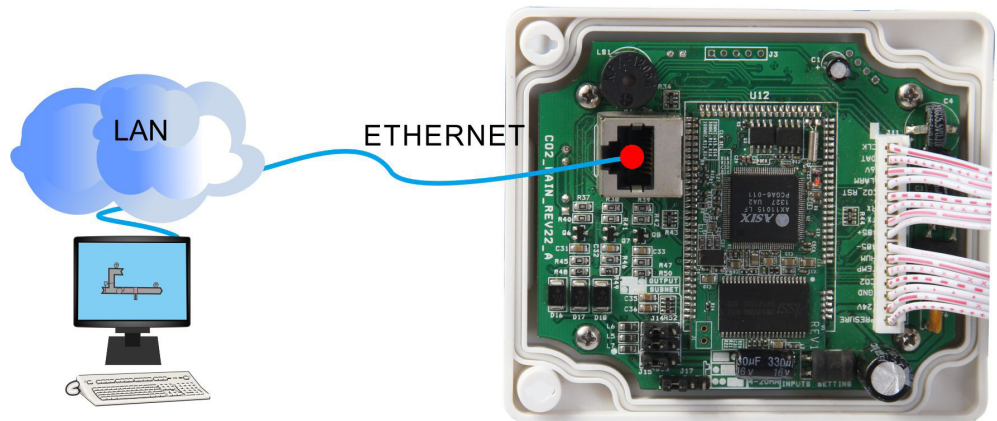

Wiring diagram for CO2-N-TH & CO2-N-X

The diagram below shows the wiring connection for the usual transducer mode of operation for the CO2-N-TH. The transducer outputs is connected to a master controller using the traditional analog output signals while CO2-N-X only have power and RS485 network, without temperature and humidity sensors.

CO2-Humidity-Temp Transmitter w/ Bacnet

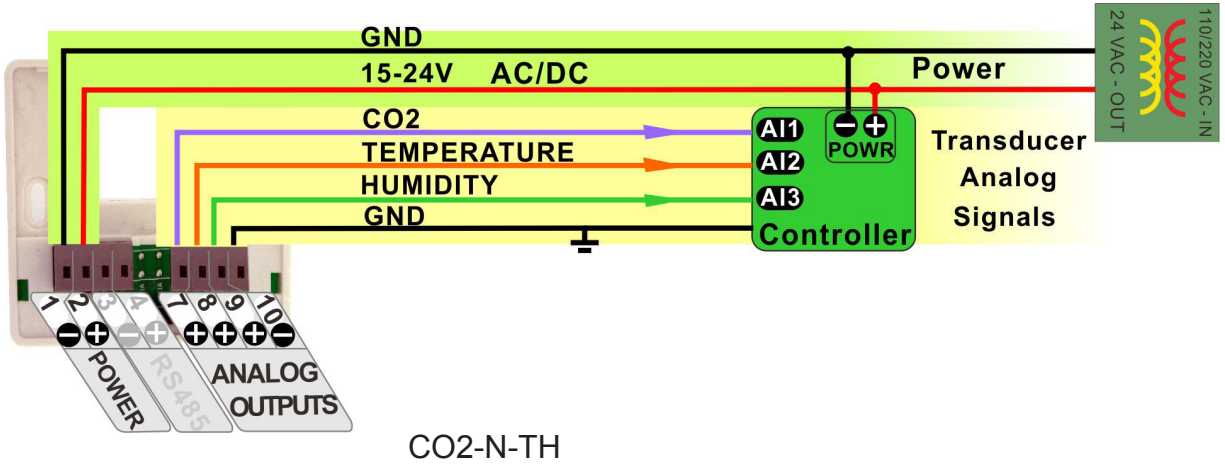

The next diagram shows the CO2-N working in the RS485 network; the node quantity can be up to 255 units. A group of sensors distributed through the building can cooperate friendly through net. The RS485 network is available for transmitting the same values digitally to other controllers.

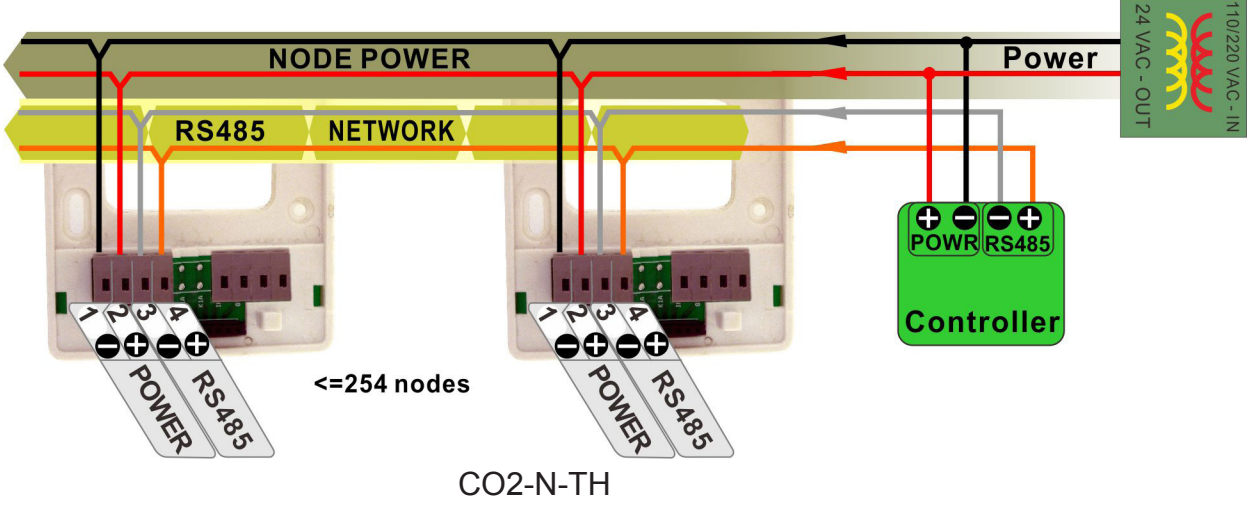

For CO2-N-TH, in this mode the device acts as a traditional transducer where it sends out three analog signals which is humidity, temperature and CO2 readings. All you need to do is to set this one single jumper to the appropriate signal type: 4-20mA, 0-10V, or 0-5V, while for it doesn't have temperature and humidity analog signals for CO2-N-X.

Jumper settings for CO2-N-TH & CO2-N-X

In this mode the device acts as a traditional transducer where it sends out three analog signals, all you need to do is to set this one single jumper to the appropriate signal type: 4-20mA, 0-10V, or 0-5V.

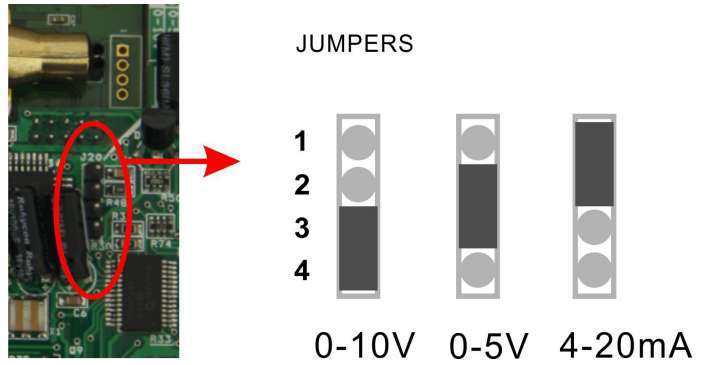

CO2-Humidity-Temp Transmitter w/ Bacnet

Voltage & Current Formula

The max and min value are the range max and min value, the range can be set by the customer.

Default Temperature Range: 0-1000 (0-100.0C)

Default Humidity Range: 0-1000 (0-100.0% rH)

Default CO2 Range: 0-3000ppm

Also the temperature, humidity, CO2 range value can be set by T3000 software, here follow the screen shot from T3000.

The screenshot shows the T3000 software interface. On the left is a tree view of the 'Default_Building' structure, including a 'Local Network' section with various devices. One device, 'CO2:91739--254', is highlighted with a red circle. The main configuration panel on the right shows settings for this device, including ID Address (254), Serial Number (91739), Firmware Version (4.7), Hardware Version (22), and Braudrate (19200). It also displays real-time sensor data: Relative Humidity (29.3%), CO2 (630 ppm), and Temperature (27.2°C). Alarm settings for Good and Fair alarms are visible. A table at the bottom right, titled 'OUTPUT Setting', shows the configured output ranges for Humidity, Temperature, and CO2.

The output default range can be set here.

NUM	Full Label	Value	Range	Min Out Scale	Max Out Scale	Unit
1	Hum	9.38	4-20mA	0.0	100.0	%
2	Temperture	0.42	4-20mA	0.0	100.0	°C
3	CO2	8.67	4-20mA	0	2000	ppm

CO2-Humidity-Temp Transmitter w/ Bacnet

Formula for Analog Outputs	
0-10V Output	Temperature(C)=[Voltage * (High_T - Low_T) + 10 * Low_T] /100
	Temperature(F)=(DegC)*9/5+32
	Humidity=[Voltage * (High_H - Low_H)+10 * Low_H]/100
	CO2=Voltage * (High_C-Low_C)/10+Low
0-5V Output	Temperature(C)=[Voltage * (High_T - Low_T) + 5 * Low_T] /50
	Temperature(F)=(DegC)*9/5+32
	Humidity=[Voltage * (High_H - Low_H) + 5 * Low_H]/50
	CO2=Voltage * (High_C - Low_C)/5+Low_C
4-20mA	Temperature(C)=(Current-4) * (High_T - Low_T) + Low_T/10
	Temperature(F)=(DegC)*9/5+32
	Humidity=(Current-4) x (High_H - Low_H) + Low_H/10
	CO2=(Current-4) x (High_C - Low_C)/16 + Low_C

Register List			
CO2-D, CO2-W with-out network	High_T=R286 Low_T=R285	High_H=R288 Low_H=R287	High_C=R290 Low_C=R289
CO2-D, CO2-W with network	High_T=R1256 Low_T=R1254	High_H=R1258 Low_H=R1257	High_C=R1260 Low_C=R1259
CO2-Node	High_T=R129 Low_T=R128	High_H=R131 Low_H=R130	High_C=R133 Low_C=R132

For example

1. Product: CO2-D
2. Output range: 0-10V output (Adjust jumper to select 0-10V in PCB board)
3. The default settings R285 = 0 and R286 = 1000, that means the default output scale is 0C-100.0C, and they can be set by customer.
4. Measuring temperature output voltage: 7.8V
5. Temperature(C)=[Voltage * (High_T - Low_T) + 10 * Low_T] /100

$$=[7.8 * (1000-0) + 10 * 0]/100$$

$$=78C$$

CO2-Humidity-Temp Transmitter w/ Bacnet

Instrument Operation

7.1) There are four keys. The first and second keys are used to increase and decrease the value and select the up down list. When click the third key, it will be back to the previous view layer. And click the forth key, it will switch to the next item.



Increase value or select up list



Decrease value or select down list



Back or return



Next or confirm



Menu display chart



The following value was taken as an example so you can understand it well.

CO2	Zone 0: Zone 254:	1. Delete node 2. Spt poor: 2500 3. Spt fair: 2500 4. Calibration: 1294
Temperature	1. Int: 23.0°C 2. Ext: 18.2°C 3. Unit: °C/ °F 4. Sensor disp.: Ext./Int.	
Humidity	1. Calibration: 34.9% 2. Heat: ON/OFF	
Miscellaneous	1. Modus ID: 251 2. Date: 2014-12-17 3. Time: 11:00 4. Ring on time: 2 5. Ring off time: 2 6. Baudrate: 19200 7. Factory reset 8. Use password: Yes/No 9. Password	





CO2-Humidity-Temp Transmitter w/ Bacnet

a. Normal state:

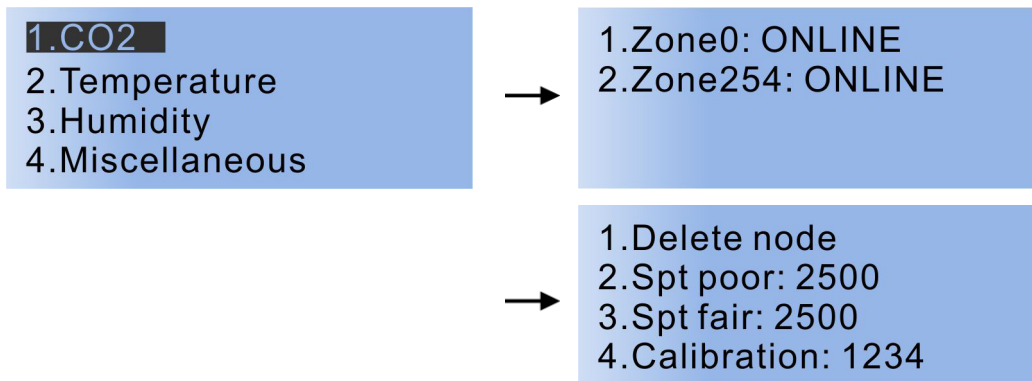



Zone0: 37.4% 17.0°C
1149 ppm (+)
2014-12-17 11:00 NET

b. Please press , it will switch to menu view as the following picture shows. Continue to press  and it will go into the CO2 list. Press  again, into the zone0's list.

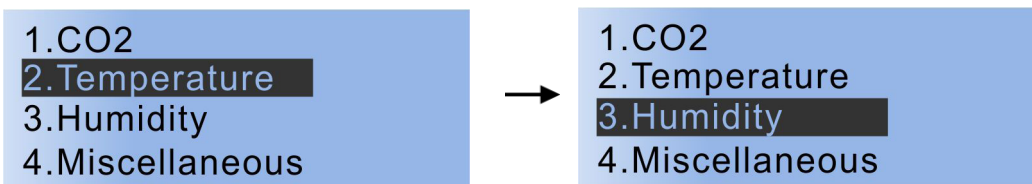





c. Please press , come back to the menu column. Press  or , and select Temperature, then press , go into the temperature list.

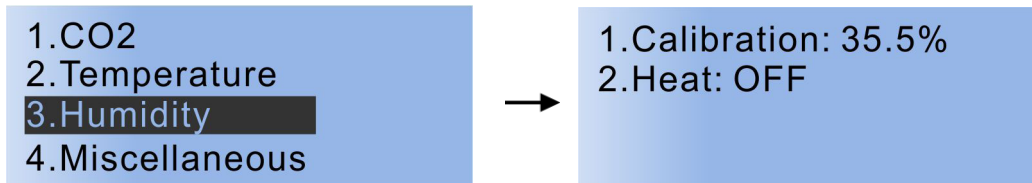

d. Please press , come back to the menu column. Press  or , and select Humidity, while press , go into the humidity list.





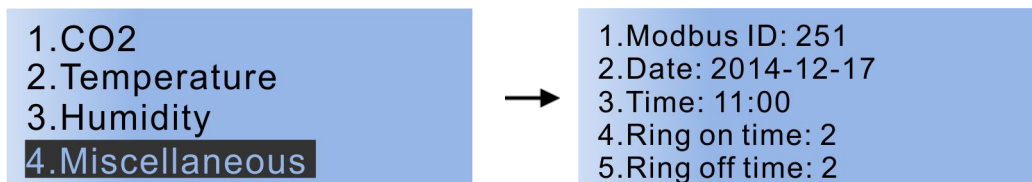

e. Please press , come back to the menu column. Press  or , and select Miscellaneous, continue to press , go into the miscellaneous list.



f. When everything is set, after a while, it will switch to the normal state as step as displayed.

CO2-Humidity-Temp Transmitter w/ Bacnet

Modbus/Bacnet switch

To select the protocol as Modbus or Bacnet, Press  to choose Miscellaneous, then press  to choose Protocol switch, press , it reads Mstp, which means you have selected Bacnet ;if you want to switch to Modbus, press , or  back to Bacnet.

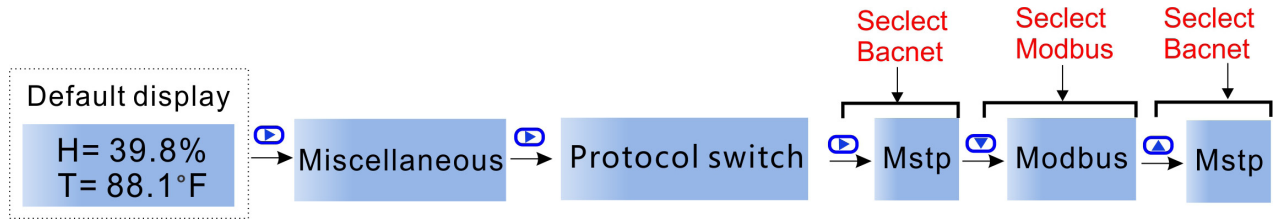

Or you can check the Bacnet Resgister List, No.9: Protocol switch. 0 = MODBUS, 1=MSTP.

Mounting Installation

1) Slotted screwdriver.

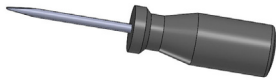

Captive screw (slotted screw)



2) Unfasten screw at cover, turn the captive screw 1/2 turn till it pops out.

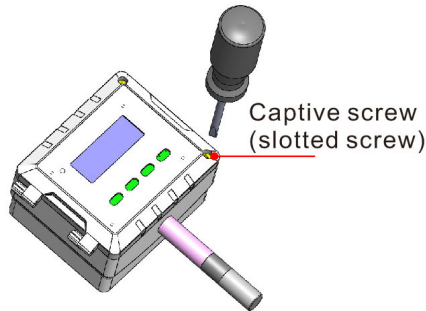

3) Open the cover.

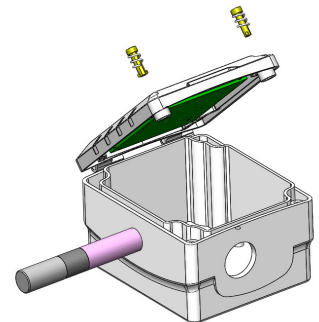

4) There are three small holes as red arrows showed below inside the box for fastening self tapping screws drilling the hole in the duct with a template

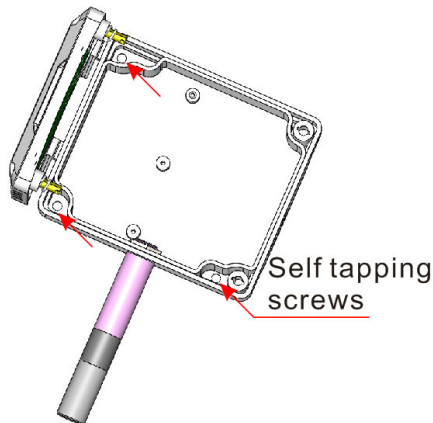

5) Re-fasten screw at cover.

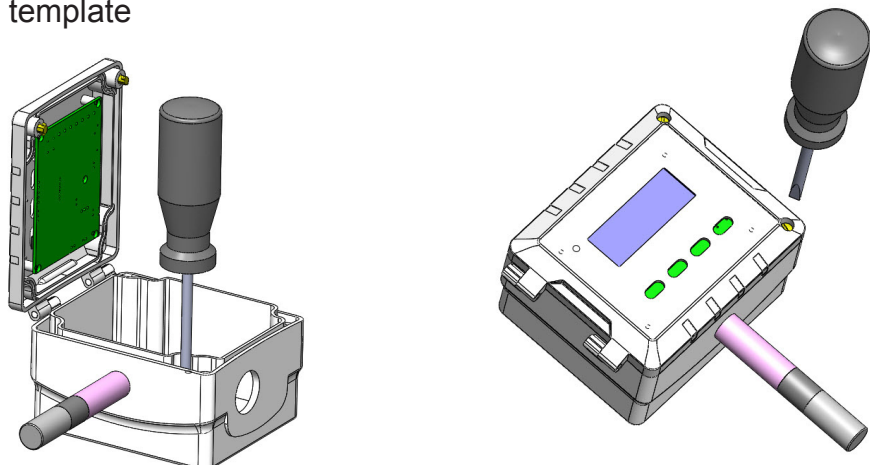

CO2-Humidity-Temp Transmitter w/ Bacnet

Accessories

CO2-W



This new Transmitter brings with it the incorporation of CO2 Monitoring. When the External CO2 Sensor is attached, the transmitter can process and display detailed information about the current CO2 count.

You can set the alarm setpoints in the menu using buttons or RS485. There are two alarm setpoints:

1. Fair alarm: the alarm output will be turned on for the ALARM_ON seconds, then be turned off for ALARM_OFF seconds, and go on on-off-on-off.
2. Poor alarm: the alarm output will be turned and kept it on.

AND there are two types of the CO2-W we have, one with ethernet and the other without ethernet.

- 1)ALARM_ON, you can set it in the register1247 with ethernet or register152 without ethernet.
- 2)ALARM_OFF, you can set it in the register1248 with ethernet or register153 without ethernet.
- 3)Fair setpoint you can set it in the register213 with ethernet or register 155 without ethernet.
- 4)Poor setpoint you can set it in the register214 with ethernet or register156 without ethernet.

CO2-N



This External CO2 Sensor uses the sensor module to calculate the current CO2 levels and uses a simple "Red/Yellow/Green" LED display to show the quality and safety of the air. When connected to the transmitter, it will display detailed information about the current CO2 count. It can also accurately monitor temperature.

External Alarm



Connected to the transmitter, this external alarm will sound and flash a red light when the CO2 levels become "POOR". It can be connected with CO2-D, CO2-W.

CO2-Humidity-Temp Transmitter w/ Bacnet

CO2-D/W in T3000 Operation

1). Connect CO2 to PC by RS485 and start T3000 software.

2). Click the button  to scan, the following view will appear and close it as the picture indicates.

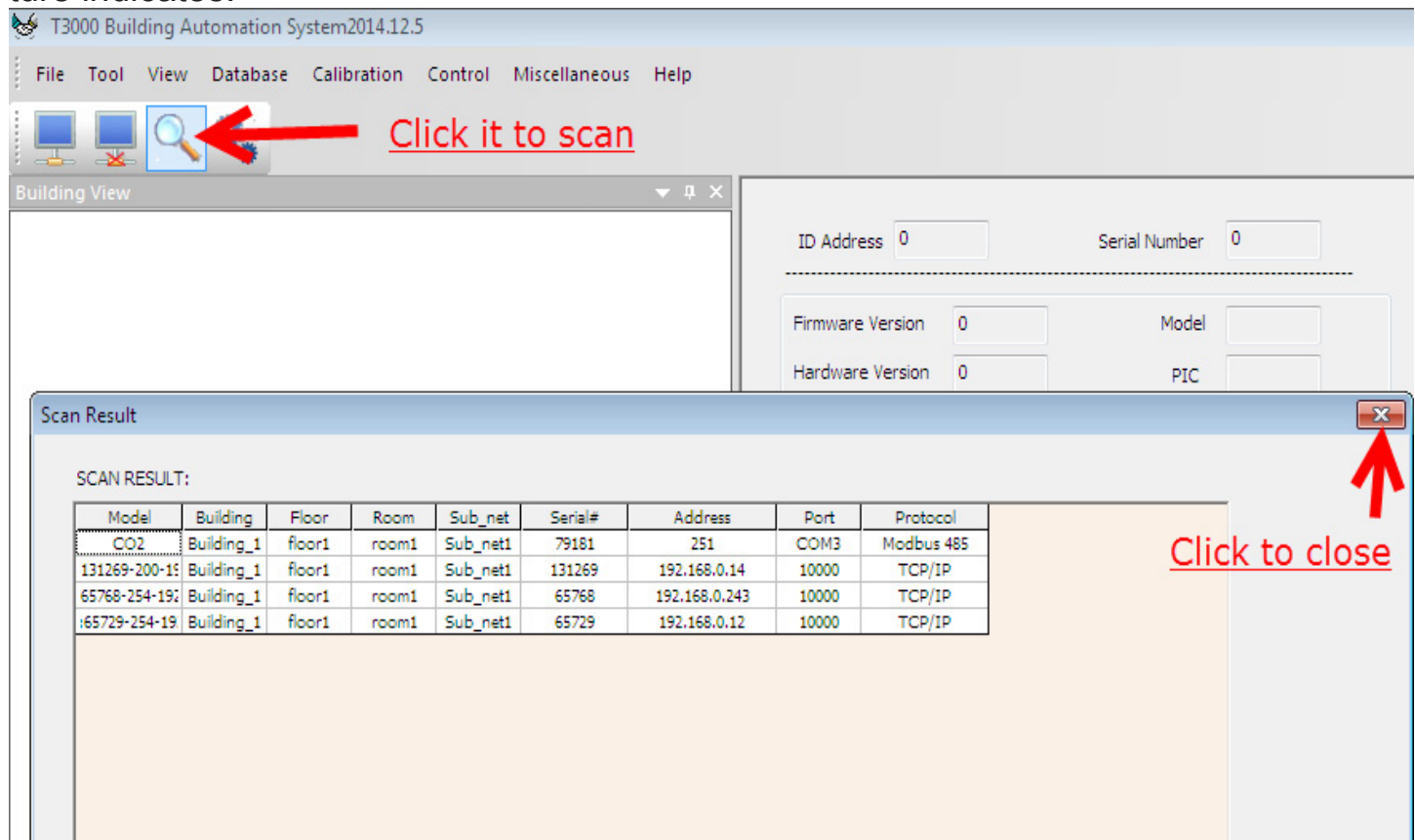

The screenshot shows the T3000 Building Automation System interface. The main window has a menu bar (File, Tool, View, Database, Calibration, Control, Miscellaneous, Help) and a toolbar with icons for various functions. A red arrow points to the scan button (magnifying glass icon) with the text "Click it to scan". Below the toolbar is the "Building View" section, which is currently empty. To the right of the Building View are input fields for "ID Address" (0), "Serial Number" (0), "Firmware Version" (0), "Model", "Hardware Version" (0), and "PIC". A "Scan Result" dialog box is open in the foreground, displaying a table of scan results. A red arrow points to the close button (X icon) in the top right corner of the dialog box with the text "Click to close".

SCAN RESULT:

Model	Building	Floor	Room	Sub_net	Serial#	Address	Port	Protocol
CO2	Building_1	floor1	room1	Sub_net1	79181	251	COM3	Modbus 485
131269-200-19	Building_1	floor1	room1	Sub_net1	131269	192.168.0.14	10000	TCP/IP
65768-254-19	Building_1	floor1	room1	Sub_net1	65768	192.168.0.243	10000	TCP/IP
65729-254-19	Building_1	floor1	room1	Sub_net1	65729	192.168.0.12	10000	TCP/IP

CO2-Humidity-Temp Transmitter w/ Bacnet

3). Click CO2 log  **CO2:79181--251** and the T3000 will show all the information of CO2.

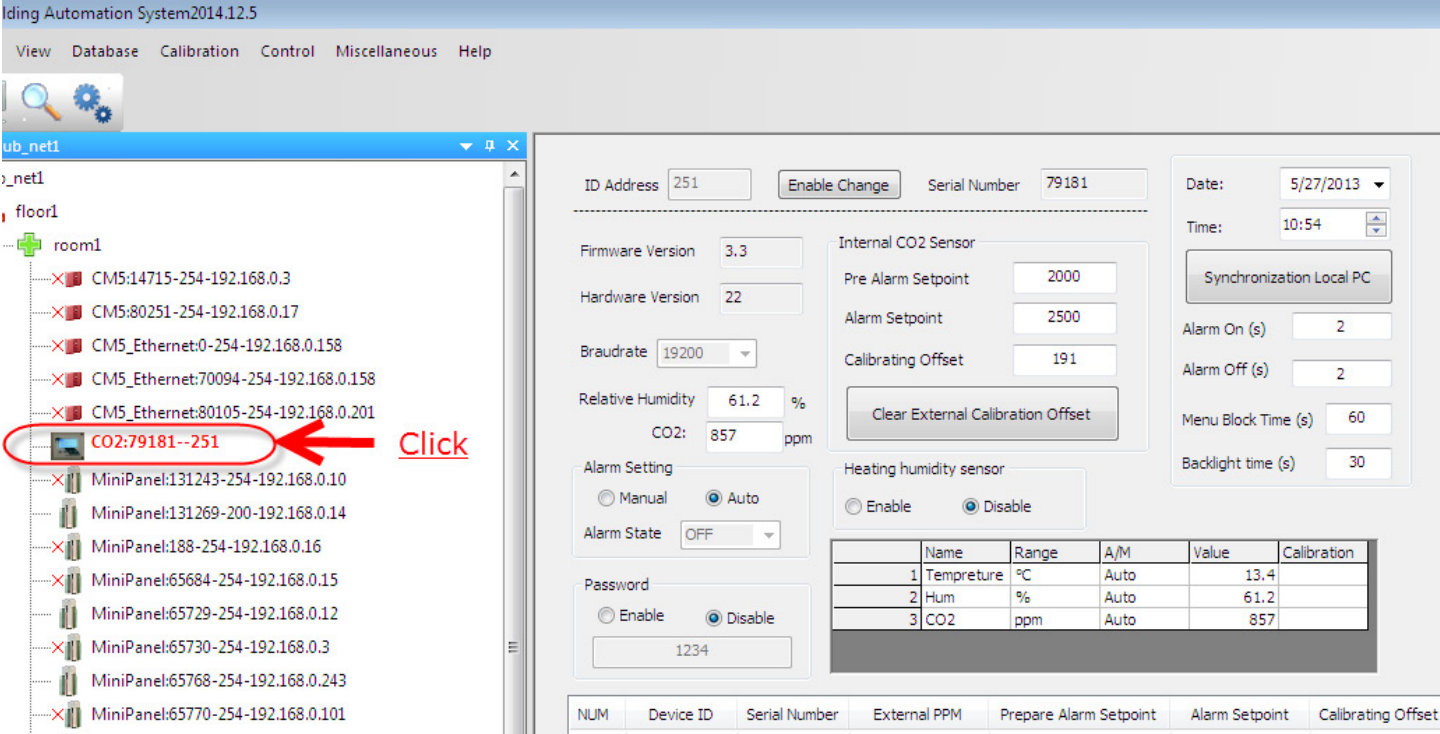

Building Automation System 2014.12.5

View Database Calibration Control Miscellaneous Help

ub_net1

ub_net1

floor1

- room1
 - CM5:14715-254-192.168.0.3
 - CM5:80251-254-192.168.0.17
 - CM5_Ethernet:0-254-192.168.0.158
 - CM5_Ethernet:70094-254-192.168.0.158
 - CM5_Ethernet:80105-254-192.168.0.201
 - CO2:79181--251**
 - MiniPanel:131243-254-192.168.0.10
 - MiniPanel:131269-200-192.168.0.14
 - MiniPanel:188-254-192.168.0.16
 - MiniPanel:65684-254-192.168.0.15
 - MiniPanel:65729-254-192.168.0.12
 - MiniPanel:65730-254-192.168.0.3
 - MiniPanel:65768-254-192.168.0.243
 - MiniPanel:65770-254-192.168.0.101

ID Address: 251 Serial Number: 79181

Date: 5/27/2013
Time: 10:54

Firmware Version: 3.3
Hardware Version: 22
Braudrate: 19200

Internal CO2 Sensor
Pre Alarm Setpoint: 2000
Alarm Setpoint: 2500
Calibrating Offset: 191

Relative Humidity: 61.2 %
CO2: 857 ppm

Alarm Setting
 Manual Auto
Alarm State: OFF

Heating humidity sensor
 Enable Disable

Menu Block Time (s): 60
Backlight time (s): 30

	Name	Range	A/M	Value	Calibration
1	Tempreture	°C	Auto	13.4	
2	Hum	%	Auto	61.2	
3	CO2	ppm	Auto	857	

NUM	Device ID	Serial Number	External PPM	Prepare Alarm Setpoint	Alarm Setpoint	Calibrating Offset
-----	-----------	---------------	--------------	------------------------	----------------	--------------------

CO2-Humidity-Temp Transmitter w/ Bacnet

4). Calibrate CO2

Press up arrow to increase value while press down arrow to decrease.

ID Address: 251 Enable Change Serial Number: 79181 Date: 5/27/2013 Time: 11:08

Firmware Version: 3.3 Internal CO2 Sensor Synchronization Local PC

Hardware Version: 22 Pre Alarm Setpoint: 2000 Alarm On (s): 2

Braudrate: 19200 Alarm Setpoint: 2500 Alarm Off (s): 2

Relative Humidity: 63.7% Calibrating Offset: 192 Menu Block Time (s): 60

CO2: 988 ppm Clear External Calibration Offset Backlight time (s): 30

Alarm Setting: Manual Auto Heating humidity sensor: Enable Disable

Alarm State: OFF

Password: Enable Disable 1234

	Name	Range	A/M	Value	Calibration
1	Tempreture	°C	Auto	13.1	
2	Hum	%	Auto	63.7	
3	CO2	ppm	Auto	988	

NUM Device ID Serial Number External PPM Prepare Alarm Setpoint Alarm Setpoint Calibrating Offset

Click

CO2-Humidity-Temp Transmitter w/ Bacnet

5). Calibrate humidity.

ID Address Serial Number

Firmware Version
 Hardware Version
 Braudrate
 Relative Humidity %
 CO2: ppm

Alarm Setting
 Manual Auto
 Alarm State

Password
 Enable Disable

Date:
 Time:

Internal CO2 Sensor
 Pre Alarm Setpoint
 Alarm Setpoint
 Calibrating Offset

Heating humidity sensor
 Enable Disable

	Name	Range	A/M	Value	Calibration
1	Tempreture	°C	Auto	13.2	<input type="text"/>
2	Hum	%	Auto	63.8	<input type="text"/>
3	CO2	ppm	Auto	993	<input type="text"/>

[Click](#)

NUM	Device ID	Serial Number	External PPM	Prepare Alarm Setpoint	Alarm Setpoint	Calibrating Offset

- 23 -

CO2-Humidity-Temp Transmitter w/ Bacnet

6). Calibrate temperature.

ID Address Serial Number

Firmware Version
 Hardware Version
 Baudrate
 Relative Humidity %
 CO2: ppm

Alarm Setting
 Manual Auto
 Alarm State

Password
 Enable Disable

Date:
 Time:

 Alarm On (s)
 Alarm Off (s)
 Menu Block Time (s)
 Backlight time (s)

Internal CO2 Sensor

Pre Alarm Setpoint
 Alarm Setpoint
 Calibrating Offset

Heating humidity sensor
 Enable Disable

	Name	Range	A/M	Value	Calibration
1	Tempreture	°C	Auto	13.2	<input type="text" value="▲"/> <input type="text" value="▼"/>
2	Hum	%	Auto	63.8	<input type="text" value="▲"/> <input type="text" value="▼"/>
3	CO2	ppm	Auto	999	<input type="text" value="▲"/> <input type="text" value="▼"/>

NUM	Device ID	Serial Number	External PPM	Prepare Alarm Setpoint	Alarm Setpoint	Calibrating Offset

[Click](#)

CO2-Humidity-Temp Transmitter w/ Bacnet

TSTAT6-CO2 in T3000 Operation

- 1). Connect TSTAT6-CO2 to PC by RS485.
- 2). Open T3000 and it show the following view.

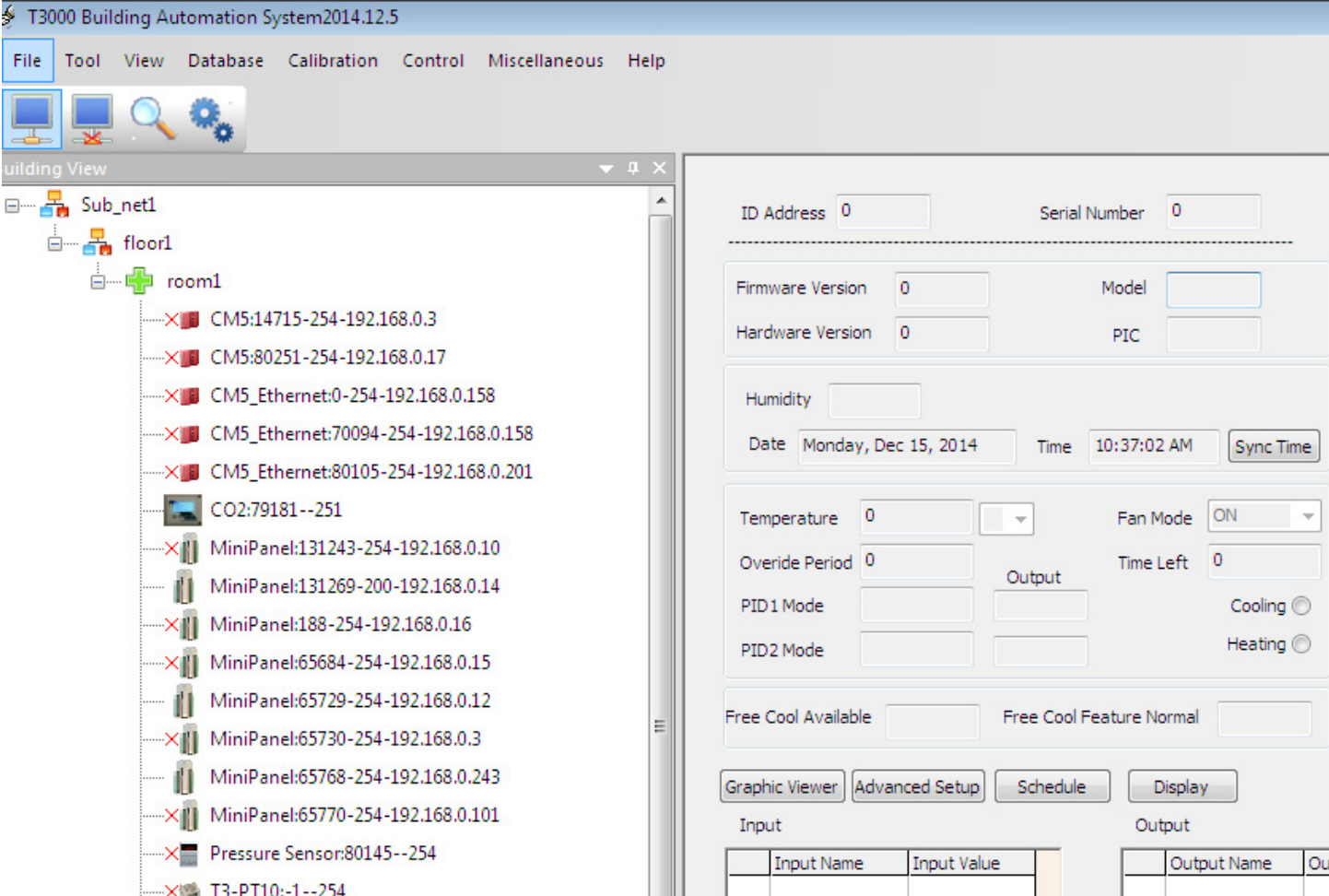

CO2-Humidity-Temp Transmitter w/ Bacnet

3). Click the button  to scan, the following view will appear and close it as the picture indicates.

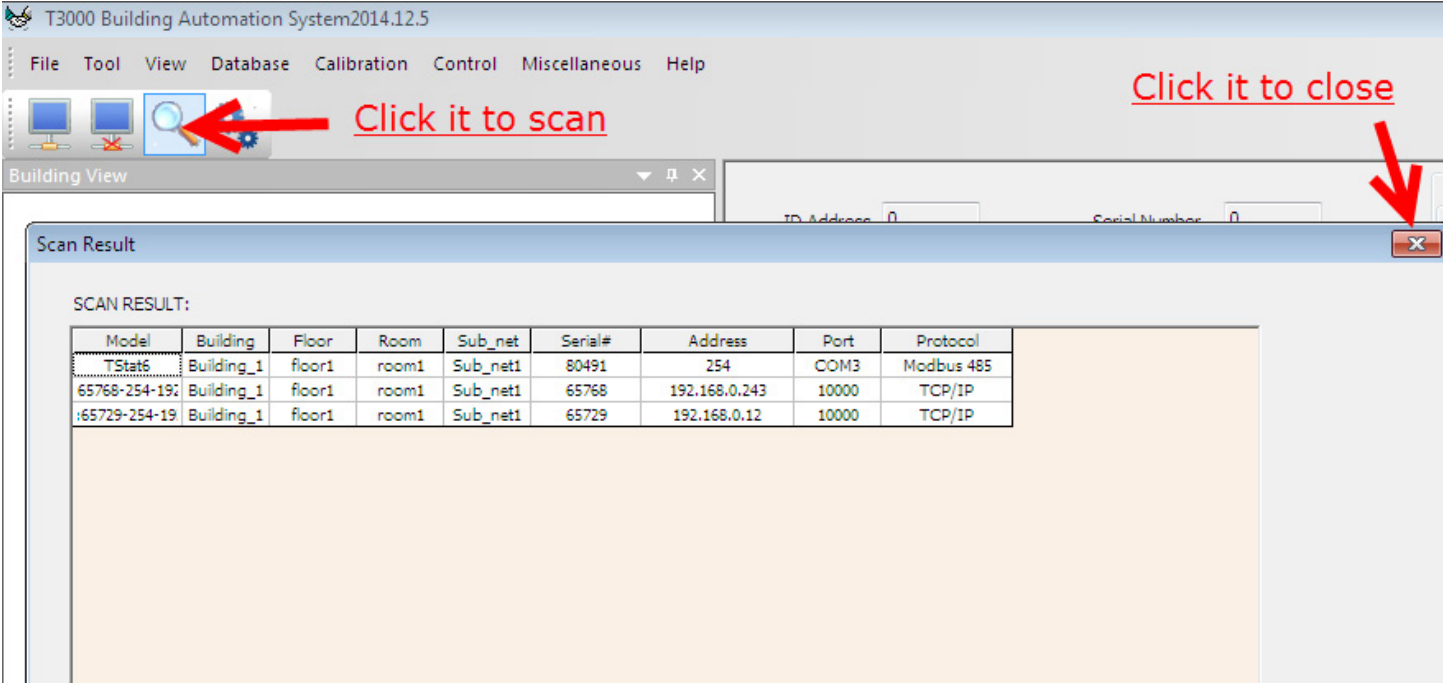

4). Click the TSTAT6 log and it will show all the information of TSTAT6.

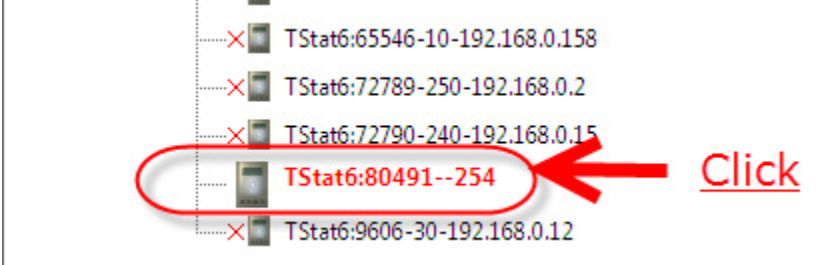

CO2-Humidity-Temp Transmitter w/ Bacnet

ID Address Serial Number

Firmware Version Model

Hardware Version PIC

Humidity

Date Time

Temperature Fan Mode

Override Period Output Time Left

PID1 Mode Cooling

PID2 Mode Heating

Free Cool Available Free Cool Feature Normal

Temperature and Setpoint

Setpoint

	DAY	NIGHT
Occupied	<input checked="" type="checkbox"/>	<input type="checkbox"/>
Cooling	11.0 C	30.0 C
Heating	9.0 C	15.0 C
Set Point	<input type="text" value="10.0 C"/>	<input type="text" value="21.0 C"/>

Max=50

Current Temperature

12.4 C

Min=10

DAY

NIGHT

Input

	Name	Value
1	Internal Sensor	12.4 C
2	Input 1	1012
3	Input 2	1012
4	Input 3	1012
5	Input 4	1012
6	Input 5	1012
7	Input 6	1013
8	Input 7	1012
9	Input 8	1012
10	Humidity Sensor	0.0%
11	CO2 Sensor	1649ppm
12	Lighting Sensor	1 LUX

Output

	Name	Value
1	Output 1	0%
2	Output 2	0%
3	Output 3	0%
4	Output 4	Off
5	Output 5	On
6	Output 6	0.0%
7	Output 7	100.0%

CO2-Humidity-Temp Transmitter w/ Bacnet

5). Calibrate CO2

Graphic Viewer **Advanced Setup** Schedule LCD Help [?]

Input

	Name	Value
1	Internal Sensor	11.9 C
2	Input 1	1011
3	Input 2	1007
4	Input 3	1012
5	Input 4	1011
6	Input 5	1012
7	Input 6	1013
8	Input 7	1012
9	Input 8	1012
10	Humidity Sensor	0.0%
11	CO2 Sensor	1141ppm
12	Lighting Sensor	1 LUX

Output

	Name	Value
1	Output 1	0%
2	Output 2	0%
3	Output 3	0%
4	Output 4	Off
5	Output 5	On
6	Output 6	0.0%
7	Output 7	100.0%

Zigbee topological graph

CO2-Humidity-Temp Transmitter w/ Bacnet

Parameter

ID Address: 254 Enable Change Refresh Exit

General Setting

Baudrate: 19200 Auto Only: Input Filter: 2

Keypad Select: 4A Setpoint Increments: 1.0 Powerup Setpoint: 20 Short Cycle Delay: 0

Powerup Mode: Last Sequence: Fan Coil Rounding display: normal Keypad Lock: Lock On

Temp Unit: °C heat/cool changeover: Auto (PID) Backlight OFF Time: 1 min

Timer

General Setting

Timer On: 0 Timer Off: 0 Units: Second Time Left: 0 min Override Period: 0 min

Timer left: Timer Select: Period timer

PIR Sensor Setting

Enable/Disable: Disable Setpoint Display: Temperature

Sensitivity: 100

Day Setpoint

Loop	Day/Occ Setting	Max	Min	Cooling Dead Band	Heating Dead Band
Loop1	10.0	50	10	1.0°C	1.0°C
Loop2	200.0			0.1	0.1
Loop3	51455			135	4

Night Setpoint

Night/Unocc Mode: Office Cooling SetPoint: 300°C Heating SetPoint: 150°C

Custom Sensor Table

Table 1

Table 2

Setpoints

	DAY	NIGHT
1 SP/2 SP:	2 SP	2 SP
COOL DB:	1	1
Setpoint:	10	21
Heat DB:	1	1
Heat SP:	9	15
COOL SP:	11	30

PID

Loop	Input select	Input value	Setpt value	Output	Pterm	Item
Loop1	HUM TEM	19.0°C	10	100%	6.0	5.0
Loop2	Internal TEM	UNUSED	200.0	44%	100.0	1.0
Loop3	Internal TEM	UNUSED	51455	50%	0.8	0.1

PID2 off Setpoint: 300.0

Special Features

Free cooling Outdoor Reset

Airflow Setting

Valve Travel Time: 90

Inputs

Outputs

Outputs Table

Click it

Setpoint Increments: 1.0 Powerup Setpoint: 20 Short Cycle Delay: 0

Mode: Default 20

Input Set Dialog

	Input Name	Value	Auto/Man	Calibration	Filter	Range	Function	Custom Tables
0	Internal Sensor	12.2°C	Auto	Adjust...		°C	N/A	N/A
1	Input 1	1012	Auto	Adjust...	3	Raw	Normal	N/A
2	Input 2	997	Auto	Adjust...	3	Raw	Normal	N/A
3	Input 3	1012	Auto	Adjust...	3	Raw		N/A
4	Input 4	1011	Auto	Adjust...	3	Raw		N/A
5	Input 5	1012	Auto	Adjust...	3	Raw		N/A
6	Input 6	1012	Auto	Adjust...	3	Raw		N/A
7	Input 7	1012	Auto	Adjust...	3	Raw		N/A
8	Input 8	1012	Auto	Adjust...	3	Raw	Normal	N/A
	Humidity Sensor	0.0%	Auto	Adjust...	3			
	CO2 Sensor	1137ppm	Auto	Adjust...	3			

Write the real value

Save Fresh Exit

CO2-Humidity-Temp Transmitter w/ Bacnet

6). Calibrate humidity

Auto Only Input Filter Occupied setpoint control Mode Default

Setpoint Increments Powerup Setpoint Short Cycle Delay

Input Set Dialog

	Input Name	Value	Auto/Man	Calibration	Filter	Range	Function	Custom Tables
0	Internal Sensor	13.0°C	Auto	Adjust...		°C	N/A	N/A
1	Input 1	1011	Auto	Adjust...	3	Raw	Normal	N/A
2	Input 2	1012	Auto	Adjust...	3	Raw	Normal	N/A
3	Input 3	1011	Auto	Adjust...	3	Raw		N/A
4	Input 4	1011	Auto	Adjust...	3	Raw		N/A
5	Input 5	1012	Auto	Adjust...	3	Raw		N/A
6	Input 6	1012	Auto	Adjust...	3	Raw		N/A
7	Input 7	1011	Auto	Adjust...	3	Raw		N/A
8	Input 8	1011	Auto	Adjust...	3	Raw	Normal	N/A
	Humidity Sensor	0.0%	Auto	Adjust...	3			
	CO2 Sensor	1392ppm	Auto	Adjust...	3			

Write the real value

Save Fresh Exit

7). Calibrate temperature.

Auto Only Input Filter Mode Default

Setpoint Increments Powerup Setpoint Short Cycle Delay

Input Set Dialog

Write the real value

	Input Name	Value	Auto/Man	Calibration	Filter	Range	Function	Custom Tables
0	Internal Sensor	13.0°C	Auto	Adjust...		°C	N/A	N/A
1	Input 1	1011	Auto	Adjust...	3	Raw	Normal	N/A
2	Input 2	1012	Auto	Adjust...	3	Raw	Normal	N/A
3	Input 3	1011	Auto	Adjust...	3	Raw		N/A
4	Input 4	1011	Auto	Adjust...	3	Raw		N/A
5	Input 5	1012	Auto	Adjust...	3	Raw		N/A
6	Input 6	1012	Auto	Adjust...	3	Raw		N/A
7	Input 7	1011	Auto	Adjust...	3	Raw		N/A
8	Input 8	1011	Auto	Adjust...	3	Raw	Normal	N/A
	Humidity Sensor	0.0%	Auto	Adjust...	3			
	CO2 Sensor	1392ppm	Auto	Adjust...	3			

Save Fresh Exit

CO2-Humidity-Temp Transmitter w/ Bacnet

CO2-N in T3000 Operation

1). Connect CO2-N to PC by RS485.



2). Open T3000 and it show the following view. Click the button to scan, the following view will appear and close it as the picture indicates.

The screenshot shows the T3000 software interface with a 'Scan Result' window open. The window displays a table of detected nodes. The first row is highlighted with a red box, indicating the 'CO2 Node'.

Model	Building	Floor	Room	Sub_net	Serial#	Address	Port	Protocol
CO2 Node	fault_Buildi	floor1	room1	fault_Buildi	94464	3	COM29	Modbus 485
BB/LB/TB:65729-1-192.168.0.	fault_Buildi	floor1	room1	fault_Buildi	65729	192.168.0.109	10000	TCP/IP
BB/LB/TB:90023-1-192.168.0.	fault_Buildi	floor1	room1	fault_Buildi	90023	192.168.0.15	502	TCP/IP
BB/LB/TB:92294-1-192.168.0.	fault_Buildi	floor1	room1	fault_Buildi	92294	192.168.0.97	502	TCP/IP
3-221:94216-254-192.168.0.2	fault_Buildi	floor1	room1	fault_Buildi	94216	192.168.0.29	502	TCP/IP
J8AO6DO:95238-254-192.16.	fault_Buildi	floor1	room1	fault_Buildi	95238	192.168.0.98	502	TCP/IP
BB/LB/TB:96892-254-192.168	fault_Buildi	floor1	room1	fault_Buildi	96892	192.168.0.3	502	TCP/IP
BB/LB/TB:65550-1-192.168.0.	fault_Buildi	floor1	room1	fault_Buildi	65550	192.168.0.14	502	TCP/IP
IF1:33685761-248-192.168.0.	fault_Buildi	floor1	room1	fault_Buildi	33685761	192.168.0.14	502	TCP/IP
B/LB/TB:65569-254-192.168.0.	fault_Buildi	floor1	room1	fault_Buildi	65569	192.168.0.109	502	TCP/IP

CO2-Humidity-Temp Transmitter w/ Bacnet

3). The following view shows Background calibration for CO2-N added.

The screenshot displays the configuration interface for a CO2-NODE device. The main window shows the following settings:

- ID Address: 3
- Serial Number: 94464
- Firmware Version: 3.9
- Hardware Version: 6
- Baudrate: 9600
- Product Name: CO2 NODE

The **CO2 Automatic Compensation Background** settings are highlighted in red and include:

- Background CO2: 400 ppm
- Number of days of watch for minimum: 7 days
- Maximum adjustment per day: 1 ppm

The **CO2 Alarms** settings are also visible:

- Poor >: 800
- Fair >: 1000

The **INPUT Setting** table is as follows:

NUM	Full Label
1	Tempreture
2	Hum
3	CO2

The **OUTPUT Setting** table is as follows:

NUM	Full Label	Range	Min Out Scale	Max Out Scale
1	Tempreture	0-10v	0	1000
2	Hum	0-10v	0	1000
3	CO2	0-10v	0	2000

A red box highlights the **CO2 NODE** device in the left-hand tree view. A red arrow points from the word "added" to the CO2 NODE device.

CO2-Humidity-Temp Transmitter w/ Bacnet

3). You can use the t3000 to set the configuration. The following view shows how to set up the span of the analog outputs.

1. We have a jumper on the background of the PCB, you can set it to 0~10V, 0~5V or 4~20mA.

2. Set the range. For example, if the temperature is 20.0 c, the range you set the min out scale 0, the max out scale 1000(100.0 degree c), then the output = $20.0 / (100.0 - 0) * 10V = 2V$.

The screenshot shows the T3000 Building Automation System interface. On the left is a tree view of devices, with 'CO2 NODE' highlighted under the 'Serial Port' section. The main window displays configuration settings for this node.

Device Information:

- ID Address: 3
- Serial Number: 96860
- Firmware Version: 4
- Hardware Version: 6
- Baudrate: 19200
- Product Name: CO2 NODE

CO2 Automatic Compensation Background:

- Background CO2: 400 ppm
- Number of days of watch for minimum: 7 days
- Maximum adjustment per day: 1 ppm

CO2 Alarms:

- Poor >: 800
- Fair >: 1000

INPUT Setting Table:

NUM	Full Label	Value	Range	Calibra...
1	Tempreture	0.0	°C	UNUSED
2	Hum	0.0	%	UNUSED
3	CO2	392	ppm	5

OUTPUT Setting Table (highlighted with a red box):

NUM	Full Label	Range	Min Out Scale	Max Out Scale	Unit
1	Tempreture	0-10v	0.0	100.0	°C
2	Hum	0-10v	0.0	100.0	%
3	CO2	0-10v	0.0	2000.0	ppm

CO2-Humidity-Temp Transmitter w/ Bacnet

3. Also, you can use the modbus poll to configure it.

127	1	analog output mode, change it by setting the jumper (J20) on the board, read only
128	2	the minimum value of temperature directs to the analog output
129	2	the maximum value of temperature directs to the analog output
130	2	the minimum value of humidity directs to the analog output
131	2	the maximum value of humidity directs to the analog output
132	2	the minimum value of co2 directs to the analog output
133	2	the maximum value of co2 directs to the analog output
		e.g. co2 output: if the co2 ppm is 1000, the (minimum value, maximum value) = (0, 3000), then
		1. setting J20 to select 0V-10V output mode, so the co2 output is about $((1000\text{ppm} / (3000\text{ppm} - 0\text{ppm})) * (10\text{V} - 0\text{V})) + 0\text{V} = 3.3\text{V}$
		2. setting J20 to select 0V-5V output mode, so the co2 output is about $((1000\text{ppm} / (3000\text{ppm} - 0\text{ppm})) * (5\text{V} - 0\text{V})) + 0\text{V} = 1.65\text{V}$
		3. setting J20 to select 4mA-20mA output mode, so the co2 output is about $((1000\text{ppm} / (3000\text{ppm} - 0\text{ppm})) * (20\text{mA} - 4\text{mA})) + 4\text{mA} = 9.3\text{mA}$

CO2-Humidity-Temp Transmitter w/ Bacnet

Connecting to the device using Bacnet

The device can be connected using Bacnet. Below are the steps:

Step 1. Download Yabe software as the link: <https://tinyurl.com/ycrt9jep> and install it.

Step 2. Connect the device to the computer, select Bacnet protocol. Start the Yabe software, add the device.

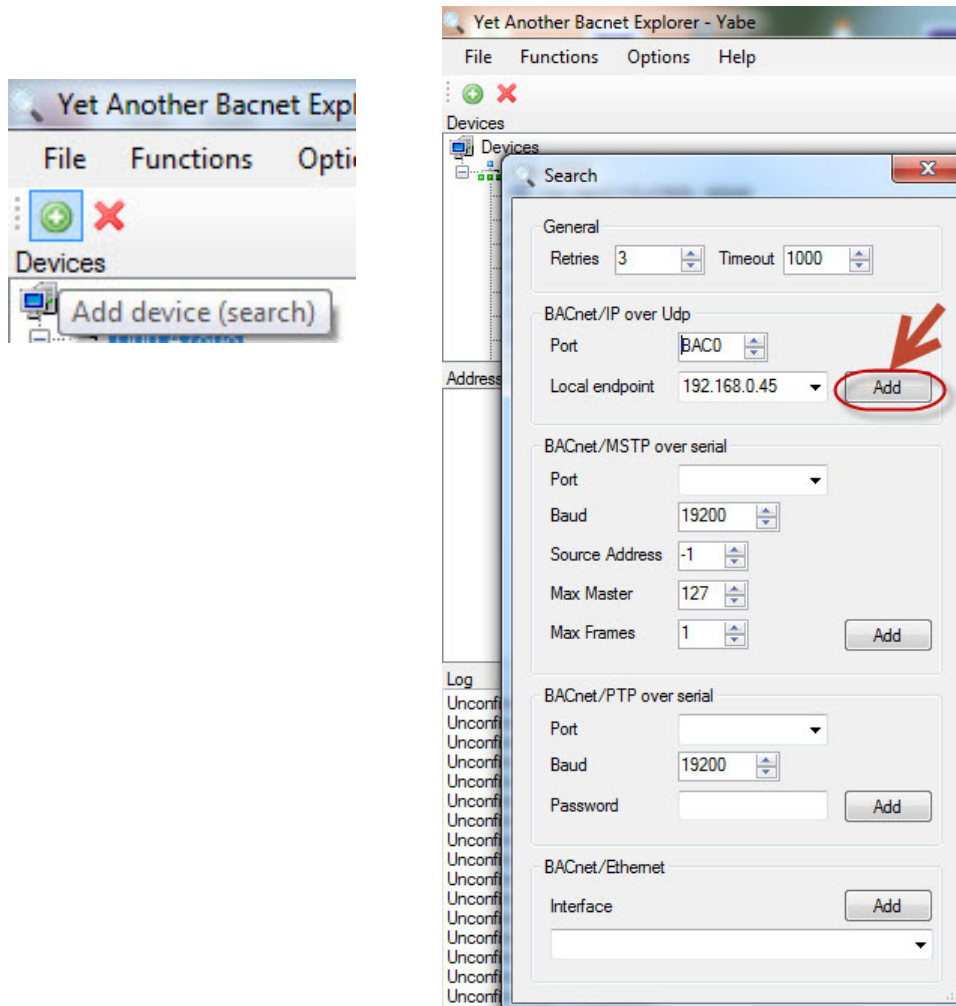

Step 3. You can find your device IP as below. Double click the left mouse button, you can find your device and the bacnet information in the "Address Space" tab.

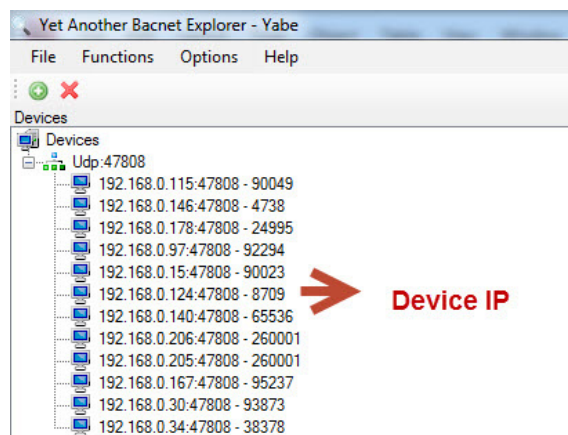

CO2-Humidity-Temp Transmitter w/ Bacnet

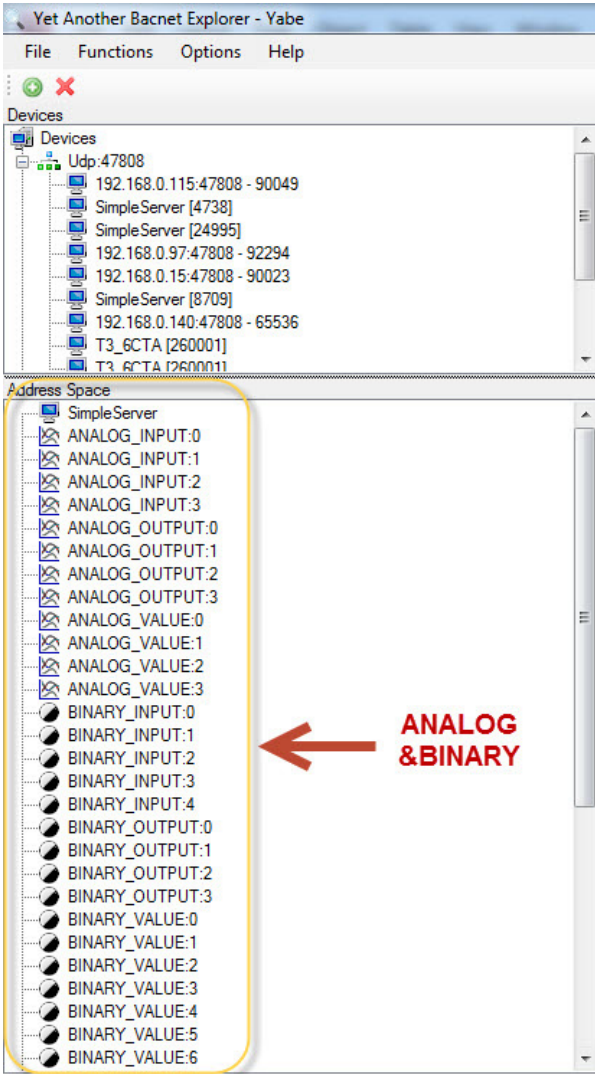

Step4. In the "Address Space" tab, click the "ANALOG_VALUE", it will show the information of "log ANALOG_VALUE" in the BacnetProperty tab. And it's the same with "ANALOG_OUTPUT" and other items.

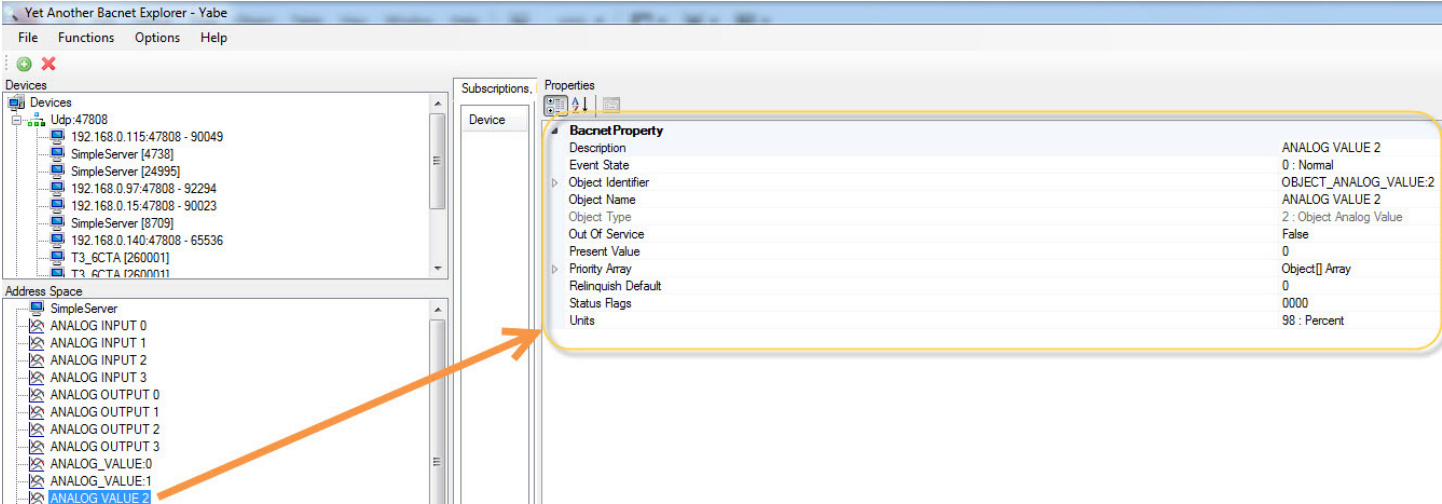

CO2-Humidity-Temp Transmitter w/ Bacnet

Address	Bytes	CO2-D&CO2-W Without Ethernet Register Description
0..1	2	Lower 2 bytes of the serial number
2..3	2	Upper 2 bytes of the serial number
4	1	firmware version lower byte. eg. FW version = 10.12, so lower byte = 12 AND high byte = 10. Fixed.
5	1	firmware version upper byte. eg. FW version = 10.12, so lower byte = 12 AND high byte = 10. Fixed.
6	1	Default Modbus device address=254
7	1	Product ID, Fixed.
8	1	Hardware version
9	1	spare
10	1	spare
11	1	Time zone
12	1	Baudrate Setting: 0 = 9600bps, 1 = 19200bps,2=38400bps,3=57600bps,4=115200bps
13	1	day lighting switch, 0 =disable day lighting feature, 1= enable
14	1	spare
15	1	reset flash. The unit will clear all configs to zero if this register being set to 0x55 = 85
16	1	Firmware Update Register, used to show the status of firmware updates
17 to 20	4	spare
21	1	Protocol switch. 3 = MODBUS,0=MSTP.
22~39	18	spare
40 to 45	6	reg40, MAC address, read only normally. (they can be written if write the regisiter 93 to 1 first, for the default setting before out of the factory.)
46	1	reg46, IP mode. 0=static IP; 1= DHCP
47 to 48	2	reg47, upper two bytes of IP address
49 to 50	2	reg49, lower two bytes of IP address
51 to 52	2	reg51, right two bytes of SUBNET MASK address
53 to 54	2	reg53, left two bytes of SUBNET MASK address
55 to 56	2	reg55, right two bytes of GATEWAY address
57 to 58	2	reg57, left two bytes of GATEWAY address
59	1	reg59, 0, TCP server, (NO USE)
60	1	reg60, listen port at TCP server mode
61 to 75		buffer mirror for changing to a new IP address, copy of reg 46 to 60
76	1	write 1 to set the ghost settings to the system and start new settings, then clear the ghost registers.
91	1	Set 1 manual to write configurations to flash
92	1	Period of write configurations to flash if configurations changed without setting register to 1. counter by second.
93	1	Enable for MAC setting. It should be set as 1 before write the new MAC to the MAC registers(100-105), and it will be cleared automatically after setting the MAC address.
94 to 99	7	Reserved for future.
100 to 105	6	reg100, MAC address, read only normally. (they can be written if write the regisiter 93 to 1 first, for the default setting before out of the factory.)
106	1	reg106, IP mode. 0=static IP; 1= DHCP

CO2-Humidity-Temp Transmitter w/ Bacnet

Address	Bytes	CO2-D&CO2-W Without Ethernet Register Description
111 to 112	2	reg111, right two bytes of SUBNET MASK address
113 to 114	2	reg113, left two bytes of SUBNET MASK address
115 to 116	2	reg115, right two bytes of GATEWAY address
117 to 118	2	reg117, left two bytes of GATEWAY address
119	1	reg119, 0, TCP server, (NO USE)
120	1	reg120, listen port at TCP server mode
121 to 135	1	buffer mirror for changing to a new IP address, copy of reg 106 to 120
136	1	write 1 to set the ghost settings to the system and start new settings, then clear the ghost registers.
137 to 171	40	Reserved
172	1	scan command< =6 start scan>/LHN add
173	1	subnet <add =1rs485 =2zigbee =4all> /LHN add
174	1	NTP command< =6,start ntp >/LHN add
175 to 178	4	Time Server0 ipaddress
179 to 182	4	Time Server1 ipaddress
183 to 186	4	Time Server2 ipaddress
187 to 190	4	Time Server3 ipaddress
191 to 194	4	Time Server4 ipaddress
195 to 198	4	Time Server5 ipaddress
199	1	Time Sync result: 0-Fail 1-Successful
200	1	Temperature sensor selection, 0=external, 1=internal. Read only, it will be set to 1 if the humidity module exists.
201	1	Select the unit of temperature to display on LCD. 0=degree Celsius, 1=degree Fahrenheit
202	2	The value of on board temperature sensor, the unit is degree Celsius. The resolution is 0.1 degree.
203	2	The value of on board temperature sensor, the unit is degree Fahrenheit. The resolution is 0.1 degree.
204	2	The value of external temperature sensor, the unit is degree Celsius. The resolution is 0.1 degree.
205	2	The value of external temperature sensor, the unit is degree Fahrenheit. The resolution is 0.1 degree.
206	2	The temperature offset for calibrating the internal temperature. The resolution is 0.1 degree.
207	2	Relative humidity. The resolution is 0.1%
208	2	Read only. The real frequency read from the humidity module, unuse.
209	1	Read only. The number of the calibration table points.
210	1	Internal CO2 sensor selection. The value is 1 as default.
211	2	The co2 ppm value of internal co2 sensor.
212	2	The co2 ppm offset for calibrating internal co2 sensor.
213	2	The setpoint value of fair alarm for internal co2 sensor.
214	2	The setpoint value of poor alarm for internal co2 sensor.
215 to 468	2*254	The co2 ppm value of the external co2 sensors if there are/is co2 nodes connect to it.
469 to 722	2*254	The co2 ppm offset for calibrating external co2 sensors.
723 to 976	2*254	The setpoint value of fair alarm for external co2 sensors.

CO2-Humidity-Temp Transmitter w/ Bacnet

Address	Bytes	CO2-D-E&CO2-W-E With Ethernet Register Description
200 to 239	2*40	The continuous_alarm ppm setpoint of external co2 sensor. Support 50 external nodes.
240 to 279	2*40	The ppm offset for calibrating the external co2 sensor ppm. Support 50 external nodes.
280	1	"Analog output auto or manual. Bit0 for temperature, 0 = auto, means the output value according to the temperature read from sensor; 1 = manual, means the output value according to the value set in output_manual_value_temp (register 321). Bit1 for humidity, 0 = auto, means the output value according to the humidity read from sensor; 1 = manual, means the output value according to the value set in output_manual_value_humidity (register 322). Bit2 for co2, 0 = auto, means the output value according to the co2 read from sensor; 1 = manual, means the output value according to the value set in output_manual_value_co2 (register 323)."
281	2	output_manual_value_temp
282	2	output_manual_value_humidity
283	2	output_manual_value_co2
284	1	the output mode, (0-5V,0-10V,4-20mA)
285	2	the minimum degree of temperature range corresponding to the temperature output(0-5V,0-10V,4-20mA)
286	2	the maximum degree of temperature range corresponding to the temperature output(0-5V,0-10V,4-20mA)
287	2	the minimum percent of humidity range corresponding to the humidity output(0-5V,0-10V,4-20mA)
288	2	the maximum percent of humidity range corresponding to the humidity output(0-5V,0-10V,4-20mA)
289	2	the minimum ppm of co2 range corresponding to the co2 output(0-5V,0-10V,4-20mA)
290	2	the maximum ppm of co2 range corresponding to the co2 output(0-5V,0-10V,4-20mA)
291	1	INFO_BYTE, TBD.
292	1	RS485 Baudrate, 0 = 9600, 1 = 19200
293	1	RTC second, from 0 to 59.
294	1	RTC minute, from 0 to 59.
295	1	RTC hour, from 0 to 23.
296	1	RTC day, from 1 to 31.
297	1	RTC week, from 0 to 6, 0 = Sunday.
298	1	RTC month, from 1 to 12.
299	2	RTC year, from 0 to 99 (2000 to 2099).
300	1	The password to log in the menu system. 1=Enable. 0=Disable.
301	1	The first password character, from '0' to '9'.
302	1	The second password character, from '0' to '9'.
303	1	The third password character, from '0' to '9'.
304	1	The fourth password character, from '0' to '9'.
305	2	Menu block time. The menu will back to idle state after this seconds.
306	2	Backlight keep time. The backlight will turn off after this seconds
307	1	External node plus&play. 1=Enable, 0=Disable.
308	1	Device number in the scan database, include the master unit itself.
309	1	Set 1 to clear the scan database
310 to 314	5	First device of the database, the display unit take it.
		5 bytes: 1st = address, 2nd..5th = serial number

CO2-Humidity-Temp Transmitter w/ Bacnet

Address	Bytes	CO2-D-E&CO2-W-E With Ethernet Register Description
315 to 319	5	Second device of the database, the first external sensor.
		5 bytes: 1st = address, 2nd..5th = serial number
		If the address is 0 or 255, that means not device behind.
320 to 324	5	...
...	5	...
...	5	...
510	5	The end of the database

CO2-Humidity-Temp Transmitter w/ Bacnet

Address	Bytes	CO2-D-E&CO2-W-E With Ethernet Register Description
977 to 1230	2*254	The setpoint value of poor alarm for external co2 sensors.
1231	2	The value to eliminate the pulse of the co2 ppm.
1232	1	The filter to make the ppm value smoothly, it is 5 as default.
1233	1	Enable/Disable the password for the menu system operation. 0=Disable, 1=Enable.
1234	1	The first digital of the password. Should be from 0 to 9.
1235	1	The second digital of the password. Should be from 0 to 9.
1236	1	The third digital of the password. Should be from 0 to 9.
1237	1	The fourth digital of the password. Should be from 0 to 9.
1238	1	The century of the real time clock.
1239	1	The year of the real time clock.
1240	1	The month of the real time clock.
1241	1	The date of the real time clock.
1242	1	The weekday of the real time clock.
1243	1	The hour of the real time clock.
1244	1	The minute of the real time clock.
1245	1	The second of the real time clock.
1246	1	Alarm auto/manual control. Bit7: 0 = auto, 1 = manual; bit0:1 = pre_alarm; bit1: 1 = continuous_alarm; bit(1:0): 00 = stop_alarm
1247	1	The alarm output turn on time, <= 20 seconds.
1248	1	The alarm output turn off time, <= 20 seconds.
1249	1	Alarm output delay time. It delays the alarm output when the alarm is triggered. It is 5 seconds as default.
1250	1	Analog output auto/manual control. Bit 0 directs to temperature output, Bit 1 directs to humidity output, Bit 2 directs to co2 output. 0=Auto, 1=Manual.
1251	2	The manual value of temperature.
1252	2	The manual value of humidity.
1253	2	The manual value of co2.
1254	1	Analog output mode, read only, select by jumper. 1=4-20mA, 2=0-5V, 3=0-10V
1255	2	The minimum value of temperature for analog output.
1256	2	The maximum value of temperature for analog output.
1257	2	The minimum value of humidity for analog output.
1258	2	The maximum value of humidity for analog output.
1259	2	The minimum value of co2 for analog output.
1260	2	The maximum value of co2 for analog output.
1261	1	The period for the menu system to stay at the submenu. It goes to the main menu when it expires in the submenu.
1262	1	The period for the LCD backlight keep on. The backlight turns on when key is triggered, and turns off when it expires.
1263	1	Enable/Disable the plug-and-play feature of the external nodes. 0=disable, 1=enable.
1264	1	The number of co2 sensors connect to the unit, includes the internal co2 sensor.
1265	1	Set 1 to reset the scan table.

CO2-Humidity-Temp Transmitter w/ Bacnet

Address	Bytes	CO2-D-E&CO2-W-E With Ethernet Register Description
1266 to 1270	1*5	The first co2 node information. Normally it is the unit itself.
		register1266: the modbus ID of the co2 sensor.
		register1267..1270: the serial number of the co2 sensor.
1271 to 1275	1*5	The secod co2 node information. Normally, it is the first external co2 node.
1276 to 1280	1*5	The third co2 node information.
...		
...		

CO2-Humidity-Temp Transmitter w/ Bacnet

Address	Bytes	CO2-Node Modbus Register Description
0 to 3	4	Serial Number - 4 byte value. Read-only
4 to 5	2	Software Version – 2 byte value. Read-only
6	1	ADDRESS. Modbus device address
7	1	Product Model. This is a read-only register that is used by the microcontroller to determine the product
8	1	Hardware Revision. This is a read-only register that is used by the microcontroller to determine the hardware rev
9	1	PIC firmware version
10	1	PLUG_N_PLAY_ADDRESS, 'plug n play' address, used by the network master to resolve address conflicts. See VC code for algorithms
15	1	Base address selection.0 = Protocol address,1 = PLC address.
16	1	Firmware Update Register, used to show the status of firmware updates
17 to 99		Blank, for future use
100	2	adc value of co2 voltage output, not used, read only
101	2	adc value of temperature voltage output, not used, read only
102	2	adc value of humidity voltage output, not used, read only
103	2	adc value of co2 current output, not used, read only
104	2	adc value of temperature current output, not used, read only
105	1	adc value of humidity current output, not used, read only
106	2	adc value of on board thermistor sensor, read only
107	2	adc value of on board light sensor, read only
108	2	co2 value (ppm). It will be calibrated if write to it.
109	2	co2 calibration offset. User can change it to calibrate the co2 ppm. It will be changed also if user write the data to register co2 ppm
110	1	Delta value for eliminating the pulse ppm value. The default value is 200.
111	2	Filter times, make the ppm value go smooth. The default value is 5.
112	2	The fair alarm ppm setpoint of co2 sensor.
113	2	The poor alarm ppm setpoint of co2 sensor.
114	1	co2 alarm status: 0b'xxxx 1xxx': co2 poor 0b'xxxx 01xx': co2 fair 0b'xxxx 001x': co2 good
115	1	the version number of humidity sensor
116	2	the relative humidity
117	2	the frequency value read from humidity sensor, read only
118	1	the number of calibration points of the humidity sensor
119	2	degree celsius temperature value of the humidity sensor
120	2	degree fahrenheit temperature value of the humidity sensor
121	2	celsius degree temperature value of the on board thermistor sensor
122	2	fahrenheit degree temperature value of the on board thermistor sensor
123	2	the offset for calibrating the on board thermistor sensor
124	1	select the temperature direct to analog output: 0: on board thermistor sensor, default setting

CO2-Humidity-Temp Transmitter w/ Bacnet

Address	Bytes	CO2-Node Modbus Register Description
125	1	select the temperature unit direct to analog output: 0: degree celsius 1: degree fahrenheit, default setting
126	2	Lighting value, for feature
127	1	analog output mode, change it by setting the jumper (J20) on the board, read only
128	2	the minimum value of temperature directs to the analog output
129	2	the maximum value of temperature directs to the analog output
130	2	the minimum value of humidity directs to the analog output
131	2	the maximum value of humidity directs to the analog output
132	2	the minimum value of co2 directs to the analog output
133	2	the maximum value of co2 directs to the analog output e.g. co2 output: if the co2 ppm is 1000, the (minimum value, maximum value) = (0, 3000), then 1. setting J20 to select 0V-10V output mode, so the co2 output is about $((1000\text{ppm} / (3000\text{ppm} - 0\text{ppm})) * (10\text{V} - 0\text{V})) + 0\text{V} = 3.3\text{V}$ 2. setting J20 to select 0V-5V output mode, so the co2 output is about $((1000\text{ppm} / (3000\text{ppm} - 0\text{ppm})) * (5\text{V} - 0\text{V})) + 0\text{V} = 1.65\text{V}$ 3. setting J20 to select 4mA-20mA output mode, so the co2 output is about $((1000\text{ppm} / (3000\text{ppm} - 0\text{ppm})) * (20\text{mA} - 4\text{mA})) + 4\text{mA} = 9.3\text{mA}$

500		co2 automatic compensation background enable or disable. 0 = Disable, 1 = Enable
501		"Background CO2", default is 400ppm, minimum is 390, max is 500. "
502		Maximum adjustment per day" default is 1ppm, max is 10 ppm, minimum is 1
503		"Number of days to watch for minimum" , default is 7 days. Max is 30 days. Minimum is 2 days.
505		co2 background calibration offset

CO2-Humidity-Temp Transmitter w/ Bacnet

Value	CO2-Node Bacnet Object Description
AV1	SerialNumber LowByte
AV2	SerialNumber HighByte
AV3	SoftWare Version
AV4	Modbus id
AV5	Product Model
AV6	Instance
AV7	Station Number
AV8	BaudRate
AV9	Update
AV10	Protocol switch. 0 = MODBUS,1=MSTP.
AV11	Auto/Manual,Analog output auto/manual control. Bit 1 directs to temperature output, 0=Auto, 1=Manual.
AV12	Dew Point
AV13	Passwords
AV14	Mixing Ratio, the mass of water over the mass of dry gas, [g/kg]
AV15	Enthalpy of the air, [kJ/kg]
AV16	Spare
AV17	Temperature Offset
AV18~AV19	Spare
AV20	Temperature Filter
AV21	Spare
AV22	Temperature Unit
AV23	Output Mode
AV24~ AV25	Spare
AV26	Minimal Range for temperature
AV27	Maxium Range for temperature
AV28~AV30	Spare
AV31	Temperature Setpoint
AV32	Spare

CO2-Humidity-Temp Transmitter w/ Bacnet

Analog Input	Analog Input and Description
AI1	Spare
AI2	Temperature
AI3	Spare

Analog Output	Analog Output and Description
AO1	Spare
AO2	Temperature
AO3	Spare